

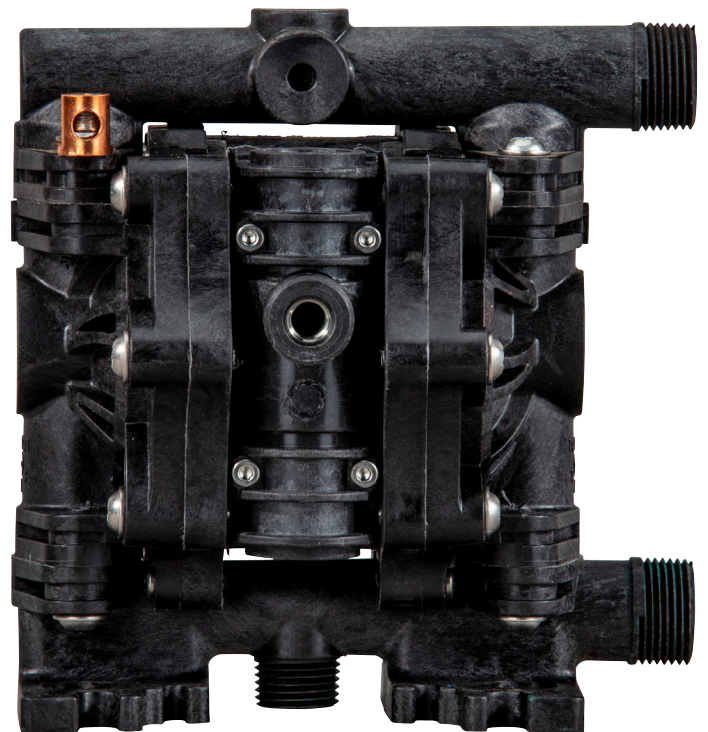

FTI AIR AODD MODELS FT025P, FT025V, & FT025C

Assembly, Installation, & Operation Manual

P/N 109814 REV 3



Record your Model and Serial Number here.

MODEL NUMBER _____

SERIAL NUMBER _____



A DIVISION OF FINISH THOMPSON INC.
921 Greengarden Rd • Erie, PA 16501 USA
Ph: 814-455-4478 • Fax: 814-455-8518
www.ftiair.com

EU Declaration of Conformity



FTI Air hereby declares that the following machine(s) fully comply with the applicable health and safety requirements as specified by the EC Directives listed. The complete product complies with the provisions of the EC Directive on machinery safety.

This declaration is valid provided that the devices are fully assembled and no modifications are made to these devices.

Type of Device:

Air Operated Double Diaphragm Pumps

Models:

FT025P, FT025V, FT025C, FT05P, FT05V, FT05A, FT05S,
FT10P, FT10V, FT10A, FT10S, FT15P, FT15V, FT15A, FT15S, FT15ZP, FT15ZV, FT15ZA, FT15ZS,
FT20P, FT20V, FT20A, FT20S, FT30A & FT30S

EC Directives:

Machinery Safety (2006/42/EC)

Applied Harmonized Standards:

EN ISO 12100

Manufacturer:

FTI Air A Division of Finish Thompson, Inc.
921 Greengarden Road
Erie, Pennsylvania 16501-1591 U.S.A

Signed,

President

23 May 2019

Person(s) Authorized to Compile Technical File: FTI Air GmbH
Otto-Hahn-Strasse 16
Maintal, D-63477 DEU
Telephone: 49 (0)6181-90878-0

EU Declaration of Conformity

Manufactured by:

Finish Thompson, Inc.
921 Greengarden Road
Erie, Pennsylvania 16501 U.S.A.
Phone: 1-(814)-455-4478
Fax 1-(814)-455-8518
Email: fti@finishthompson.com
Web: www.finishthompson.com



II 2GD
Ex h IIC T6 Gb
Ex h IIIC T6 Db
FTZU 16 ATEX A473-16

This declaration applies to **FTI Air ATEX Series** AODD pumps, being designated by the letter -A- in the model number, and only manufactured out of metallic or carbon fiber filled PP designated by the model numbers FTXX[Z]A, FTXX[Z]S, or FTXX[Z]C, with metallic or carbon fiber filled non-wetted parts designated by the letters -AA- or -CD- within the model number. Pumps and their model numbers may also contain different combinations of diaphragms, balls, seats, o-rings, port connections, and other options.

Example Model Numbers: FT05C-CD-2TPC-B1-A, FT05A-AA-NNAN-B1-A, FT15ZA-AA-BBAB-B2-A

Finish Thompson declares under our sole responsibility that the product listed below conforms to the relevant provisions of EU directive 2014/34/EU of 26 February 2014 for equipment and protective systems intended for use in potentially explosive atmospheres, and is certified for safe use in Group II category 2 areas.

This product has used the following harmonized standards to verify conformance:

Non-electrical equipment for potentially explosive atmospheres: EN ISO 80079-36:2016
Basic Methods and Requirements

Non-electrical equipment intended for use in potentially explosive atmospheres: EN ISO 80079-37:2016
Protection by construction safety "ch" and control of ignition source "bh".

This product must not be used in areas other than specified above. If in doubt consult an authorized distributor, or refer to the manufacturer Finish Thompson.

Approved by:

Date: 12/03/2020

Table of Contents

Important Information - READ ME FIRST

Export Regulation Notice	5
Chemical Reaction Disclaimer	5
Safety Precautions	5-6

Pump Specifications

Materials Profiles.....	7
Technical Specifications	7
Model Number Explanation & Example Part Numbers.....	8
Performance Curve.....	8
Dimensional Drawing.....	9

Installation/Operation

Installation Drawing.....	10
Precautions.....	10
Troubleshooting.....	11

Maintenance

Recommended Tools	11
Wet End Servicing	11
Disassembly	12-13
Reassembly	14-17
Air End Servicing	17
Shaft & Bushing Replacement.....	17-18
Air Valve O-ring Replacement.....	18
Valve Gasket Replacement.....	19
Replacement Air Valve Kit Installation.....	19
Exploded View	20
Spare Parts List.....	20-23

Warranty	24
-----------------------	----

Important Information- Read Me first

IMPORTANT NOTICE

U.S. Export Administration Regulations, pursuant to ECCN 2B350, prohibit the export or re-export to certain enumerated countries of air operated double diaphragm pumps in which all wetted materials are constructed from fluoropolymers without first applying for and obtaining a license from the U.S. Bureau of Industry and Security (BIS). This affects all FTI AIR pumps constructed from PVDF with PTFE balls and diaphragms. Please contact the BIS (www.bis.doc.gov) or FTI Air with questions regarding the Regulations or a list of the countries to which they apply.

Chemical Reaction Disclaimer

The user must exercise primary responsibility in selecting the product's materials of construction which are compatible with the fluid(s) that come(s) in contact with the product. The user may consult FTI Air (manufacturer) and a manufacturer's representative/distributor agent to seek a recommendation of the product's material of construction that offers the optimum available chemical compatibility.

However neither manufacturer nor agent shall be liable for product damage or failure, injuries, or any other damage or loss arising out of a reaction, interaction or any chemical effect that occurs between the materials of the product's construction and fluids that come into contact with the product's components.

Unpacking & Inspection

Unpack the pump and examine for any signs of shipping damage. If damage is detected, save the packaging and notify the carrier immediately.

To install the pump, follow the installation instructions provided.

Safety Precautions for ATEX Pumps

⚠ WARNING: READ THIS SUPPLEMENTAL INSERT COMPLETELY BEFORE INSTALLING AND OPERATING THIS PUMP. FAILURE TO FOLLOW THESE PRECAUTIONS CAN RESULT IN SERIOUS INJURY OR DEATH.

⚠ WARNING: Static sparking can cause explosion. When operating in a hazardous area or pumping a hazardous fluid, the pump's grounding screw and entire pump system must be grounded to earth to prevent static discharge. This includes but is not limited to pipes, hoses, tanks, containers, valves, etc. Before operating the pump, ensure the electrical continuity throughout the pumping system and earth ground is 1 Ohm or less. If it is greater than 1 Ohm, re-check all grounding connections.

⚠ WARNING: Static sparking can cause explosion. Excessive fluid flow rates and improper tank filling methods can produce static electricity causing an explosion. Ensure safe fluid velocities and tank filling procedures in compliance with EN 13463-1 and CLC/TR 50404.

⚠ WARNING: Vibrations from operation may cause mounting surfaces and connections to loosen and generate a spark. Ensure the pump and connections are securely mounted and fastened prior to each operation.

⚠ WARNING: Do not exceed minimum and maximum temperature limits of pump components. A table of temperature limits is provided in the "Material Profiles" section of the manual.

⚠ WARNING: Prior to operating, check pump for any worn o-rings, gaskets, or seals. Any leaking or damaged o-rings, gaskets, or seals must be repaired or replaced immediately.

⚠ WARNING: Do not exceed maximum pressure stated on the pump serial number sticker.

⚠ WARNING: Pump exhaust may be loud and contain particles. Wear appropriate ear and eye protection. In the event of a diaphragm rupture material can be forced out of the air exhaust muffler.

⚠ WARNING: Pump must be cleaned on a regular basis to avoid dust buildup greater than 5mm.

⚠ WARNING: The surface temperature of the pump depends upon the temperature of the fluid that is being pumped. The chart below lists different fluid temperatures and the corresponding pump surface temperatures, which determine the Temperature Class when used in a hazardous area.

Fluid Temperature	Maximum Surface Temperature	Temperature Class	Maximum Allowable Surface Temperature
176° F (80° C)	176° F (80° C)	T6	85° C

Safety Precautions

⚠ WARNING: Never use a natural polypropylene or natural PVDF pump with flammable or combustible fluids/materials.

⚠ WARNING: FTI Air maximum temperature limits are based upon the material's mechanical stress only. Maximum temperature is application dependent. Consult a chemical resistance guide or the chemical manufacturer for chemical compatibility and temperature limits.

⚠ WARNING: Chemical Hazard. This pump is used for transferring many types of potentially dangerous chemicals. Always wear protective clothing, eye protection and follow standard safety procedures when handling corrosive or personally harmful materials. Proper procedures should be followed for draining and decontaminating the pump before disassembly and inspection of the pump. There may be small quantities of chemicals present during inspection.

⚠ WARNING: Hot surfaces. FTI Air pumps are capable of handling liquids with temperatures as high as 220°F (104°C). This may cause the outer areas of the pump to become hot as well and could cause burns.

⚠ WARNING: If a diaphragm rupture occurs, material being pumped may be forced out of the air exhaust. Proper care should be taken, always wear protective clothing, eye protection & follow standard safety procedures.

⚠ WARNING: When pumping hazardous liquids, or operating the pump in an enclosed room, it is important to provide ventilation for exhaust to a safe area.

⚠ WARNING: For polypropylene or PVDF pumps do not exceed 120 psig (8.3 bar) air supply.

⚠ CAUTION: Before attaching air supply to pump make sure all airline debris is clear. It is recommended to use a minimum 5µ (micron) air filter before the air valve.

⚠ CAUTION: Do not over-tighten the air inlet fitting. Too much torque could damage the air valve.

⚠ CAUTION: Before maintenance or repair, close the compressed air line supply valve, bleed the pressure and disconnect air line from the pump. Discharge line may also be pressurized. Any pressure must be relieved prior to servicing. Isolate and remove suction / discharge lines & drain the pump. Note that flooded suction systems could be subject to significant leaking through the exhaust before suction isolation valve is closed.

⚠ CAUTION: If pump is used with materials that tend to solidify or settle, the pump should be flushed after each use to prevent damage.

⚠ CAUTION: Use only genuine FTI Air replacement parts to assure compatibility & longest service life.

⚠ CAUTION: Check the temperature limits for all wetted components when choosing pump materials. See table on page 7.

⚠ EXPLOSION HAZARD! FTI Air pumps with standard materials of construction should not be used with halogenated hydrocarbons. Halogenated hydrocarbon solvents can cause explosion when used with aluminum components and will be affected by halogenated hydrocarbon solvents.

1-1-1 Trichloroethane and Methylene Chloride are the most common halogenated hydrocarbons. However, other halogenated hydrocarbon solvents are suspect if used either as part of paint or adhesive formulation, or for clean-up flushing.

For applications that may involve halogenated hydrocarbons, contact FTI Air to discuss the availability of alternative pump materials of construction.

Material Profiles

Material	Chemical Composition	Description	Operating Temperature		Relative Cost
			Minimum	Maximum	
Polypropylene	Pure Polypropylene	Thermoplastic that is resistant to alkali and strong acids.	32°F (0°C)	158°F (70°C)	\$
Conductive Polypropylene	Carbon filled Polypropylene	Thermoplastic that is resistant to alkali and strong acids and conductive.	32°F (0°C)	158°F (70°C)	\$\$
PVDF	Pure Polyvinylidene Fluoride	Strong fluoropolymer with excellent chemical resistance.	10°F (-12°C)	220°F (104°C)	\$\$\$
Neoprene	Chloroprene Rubber	General purpose elastomer with good resistance to moderate chemicals, oils, grease, solvents, and some refrigerants. Used as an o-ring backup for PTFE diaphragms.	0°F (-18°C)	212°F (100°C)	\$
Santoprene™	Fully cured EPDM rubber particles encapsulated in a polypropylene (PP) matrix	Thermoplastic elastomer with good abrasion resistance with chemical resistance to a wide range of solvents and chemicals. Injection molded with no fabric layer.	-40°F (-40°C)	225°F (107°C)	\$
PTFE	Polytetrafluoroethylene	Chemically inert. Resistant to a wide range of chemicals.	40°F (4°C)	225°F (107°C)	\$\$
FEP	Fluorinated Ethylene Propylene	Similar to PTFE in composition and chemical resistance. Used to encapsulate FKM o-rings for superior chemical resistance. Used as a seat o-ring.	40°F (4°C)	225°F (107°C)	\$\$

Santoprene™ is a registered tradename of Exxon Mobil Corp.

Specifications

Pump Type: Non-Metallic Air Operated Double Diaphragm	
Weight: PP & CFPP - 2.3 lbs (1.0 kgs) PVDF - 3.1 lbs (1.4 kgs)	Max Suction Lift: Wet - 28 ft H ₂ O (8.5 m H ₂ O) Dry - 6 ft H ₂ O (1.8 m H ₂ O)
Air Inlet: 1/8" FNPT or FBSPT	Max Flow Rate: 5.8 gpm (22 lpm)
Max Air Inlet Pressure: 120 psig (8.3 bar)	Suction/Discharge Size: I.D.: 1/4" FNPT/FBSPT O.D.: 3/4" MNPT/MBSPT
Max Material Inlet Pressure: 10 psig (0.7 bar)	Optional Center Vertical Suction Port: O.D.: 1/4" MNPT/MBSPT
Air Consumption @ 100 psi: 8 scfm (13.6 Nm ³ /hr)	Max Particle Size: 0.06" (1.8 mm)
Noise Level: 65.3 dB(A)	Max Outlet Pressure: 120 psig (8.3 bar)
	Displacement Per Stroke: 0.005 gal (0.02 liter)

Model Number Explanation & Example Part Numbers

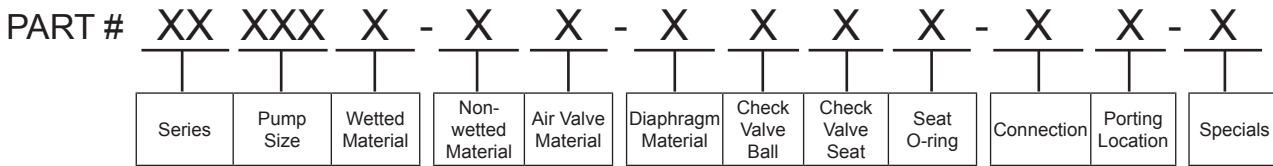

Series*

FT - Pump End
FW - Wet End

Pump Size*

025 - 1/4"

Wetted Materials*

P - Polypropylene
V - PVDF
C - Conductive polypropylene**

Non-wetted Materials

P - GFRPP
C - Conductive PP**

Air Valve Material & Thread Type

1 - GFRPP or Conductive Acetal - FNPT
2 - GFRPP or Conductive Acetal - FBSPT

Diaphragm Materials*

R - Santoprene 1 - PTFE/Neoprene

Check Valve Ball Materials*

R - Santoprene T - PTFE

Check Valve Seat Materials*

P - Polypropylene V - PVDF
C - Carbon filled PTFE**

Check Valve Seat O-Ring Materials*

R - Santoprene C - FEP/FKM

Connection

N - Universal NPT/BSPT

Porting location

1 - End (standard) 2 - Center horizontal
3 - Center vertical 4 - Center vertical suction & end discharge

Specials

K1 - PP drum pump kit
K2 - PVDF drum pump kit
P1 - Halogenated Hydrocarbon Compatible
A - ATEX**

*Required for wet end

**Required for ATEX

Example Pump P/Ns: FT025P-P1-RRPR-N1, FT025P-P1-1TPC-N1, FT025V-P1-1TVC-N1 & FT025C-C2-RRCR-N1-A

Example Wet End P/Ns: FW025P-RRPR, FW025P-1TPC, FW025V-1TVC & FW025C-RRCR

FT025P, FT025V, & FT025C Performance

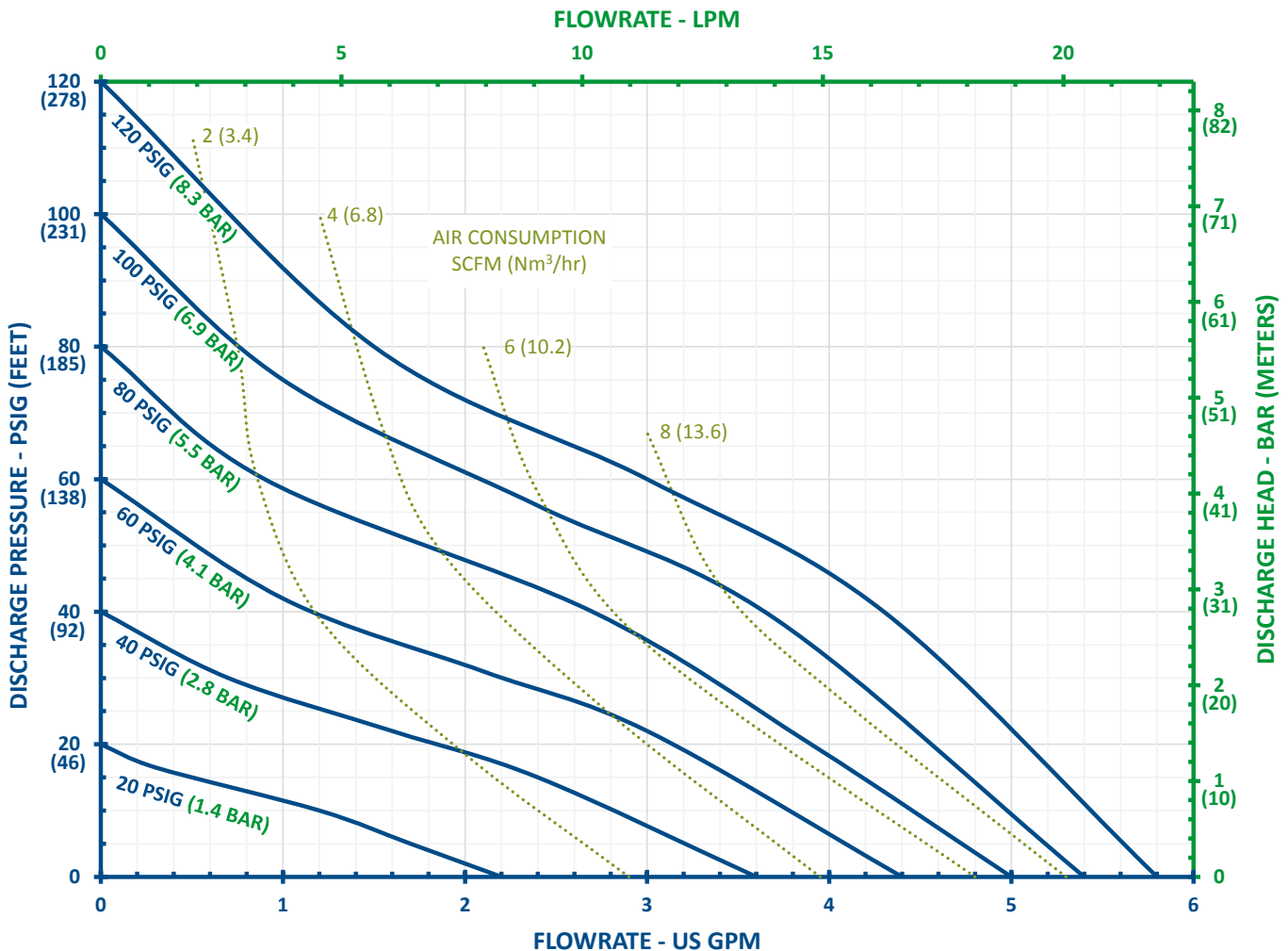

Dimensional Drawing

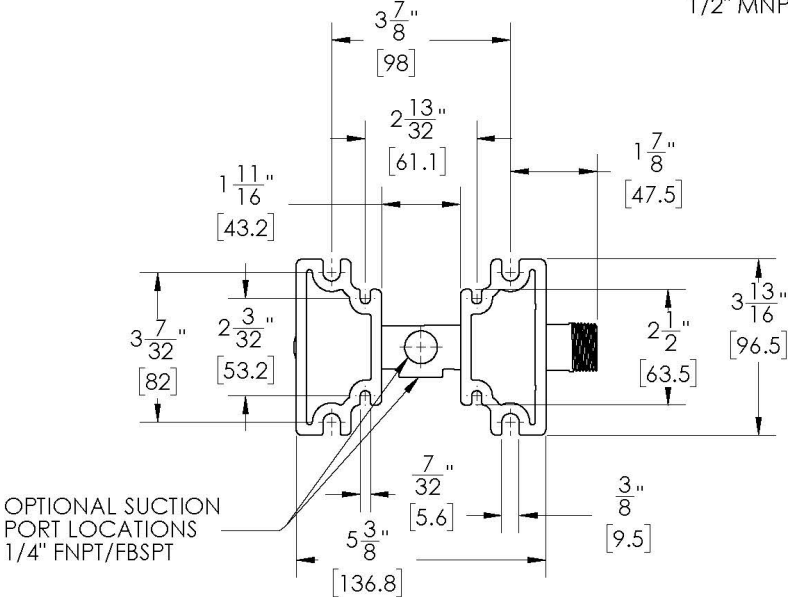
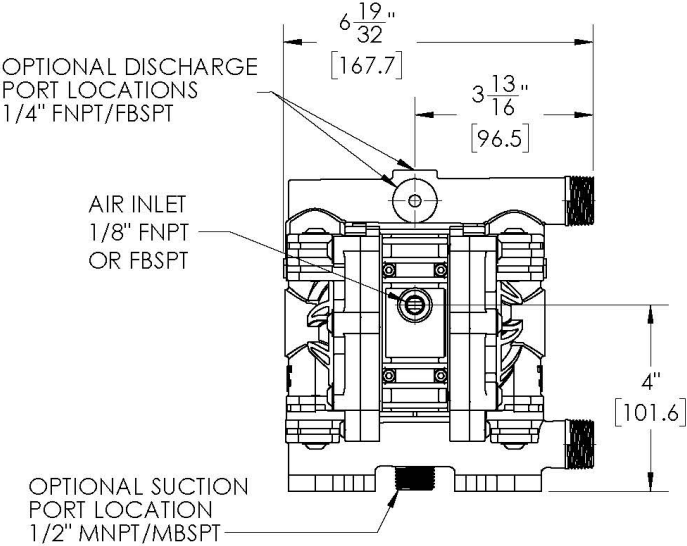
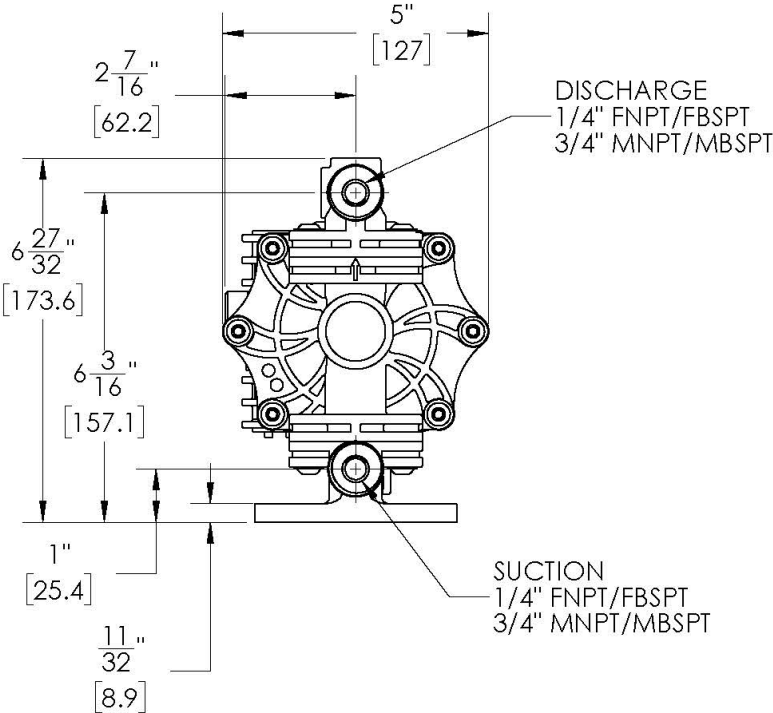

Installation Drawing

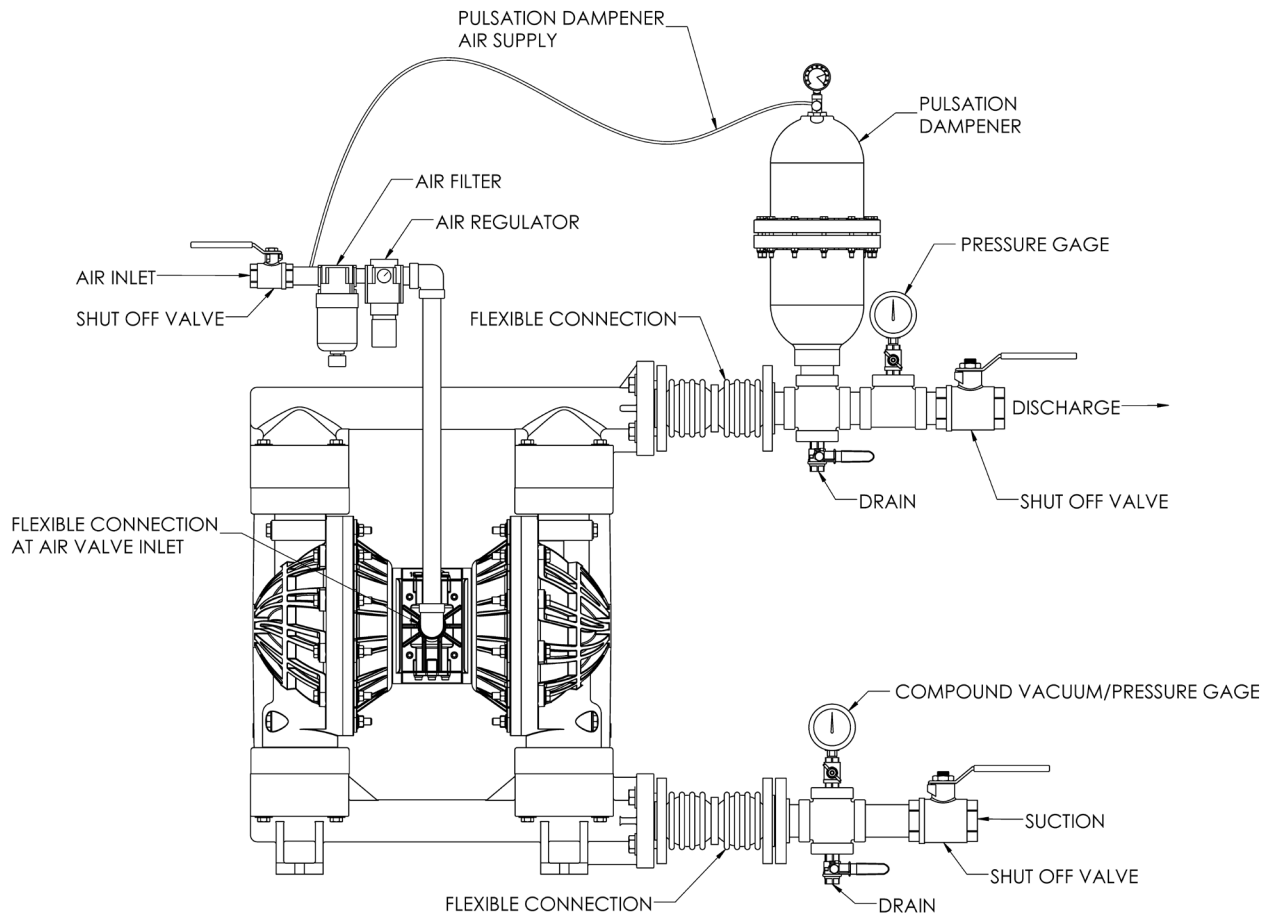

Installation / Operation Precautions

Installation and Start up

Install the pump in a vertical position or it may not prime properly. Pump should be located as close to the product being pumped as possible. Suction line length should be as short as possible and limit the number of fittings. Suction line diameter should not be reduced smaller than the suction diameter of the pump. When using rigid pipe run short sections of flexible hose or flexible connections between the pump & piping. Secure the pump to a suitable surface.

Air Supply

Connect the pump air inlet to an air supply with sufficient capacity to achieve desired performance. A pressure regulating valve should be installed to ensure air supply pressure does not exceed recommended limits.

Air Valve Lubrication

No lubrication is required for the air distribution system.

Fasteners

Re-torque all fasteners before operation. Creep of housing and gasket materials may cause fasteners to loosen. Re-torque all fasteners to the torque specifications listed on page 22 in this manual.

Air Inlet & Priming

Pump will start to operate as soon as the shut-off valve is opened. It is recommended to open the shut-off valve slowly at first. Once the pump primes; the shut-off valve can be opened additionally to increase the pump's flow. If the pump is operating but not pumping any liquid see the troubleshooting section for tips & suggestions.

Accessories

Surge suppressors & filter/regulators are available and should be used with FTI Air pumps.

Troubleshooting Tips & Suggestions

PUMP WILL NOT START OR CYCLE:

- Blocked liquid pipe or hose - Clean out or replace
- Clogged liquid chamber - Remove debris
- Diaphragm shaft bushing / o-ring leak - Replace o-rings
- Air valve carrier not shifting - Inspect and clean

ERRATIC CYCLING:

- Diaphragm failure - Replace diaphragm
- Valve ball not seating properly, worn or damaged – Inspect, remove debris or replace
- Leak in suction line - Inspect, repair or replace
- Diaphragm shaft / o-ring leak - Replace o-rings
- Air valve carrier not shifting - Inspect and clean
- Over lubrication in air valve - Inspect, degrease, clean, and reuse. Remove lubrication
- Excess moisture in air valve – Inspect, dry, reuse. Consider installing an air dryer
- Worn carrier or valve bore – measure carrier and valve bore, diametrical clearance should be between .0020" - .0050". Replace worn components as needed

PUMP CYCLES BUT WILL NOT PUMP:

- Too much suction lift - Reduce suction lift or try filling up liquid chambers with fluid
- Leak in suction line - Inspect, repair or replace
- Valve ball not seating properly, worn or damaged - Inspect, remove debris or replace
- Clogged suction pipe or hose - Inspect & clear
- Clogged strainer if used - Inspect & clear
- Diaphragm failure - Replace diaphragm

PUMPED LIQUID RELEASED FROM AIR EXHAUST

- Diaphragm failure - Replace diaphragm
- Outer plate unthreading - Tighten & re-torque

Maintenance

Recommended Tools for Servicing Pump

- 20, 27 or 30T Torx bits, (2) 5/8" socket wrenches, snap ring pliers; 3 mm hex wrench, o-ring pick, & torque wrench.

Wet End Servicing (Installing Wet End Kit)

- Relieve airline pressure and fluid line pressures before conducting maintenance.
- The pump can be drained by turning it upside down and allowing fluid to drain into an appropriate container. Use proper safety equipment when conducting maintenance as internal components may still contain the pumped media.
- Lubricate all stainless steel to stainless steel fasteners to prevent galling.

Wet End Disassembly

- 1 Remove the (4) discharge manifold bolts (item 9) from the discharge manifold (item 16) using a T30 or T27 Torx bit.

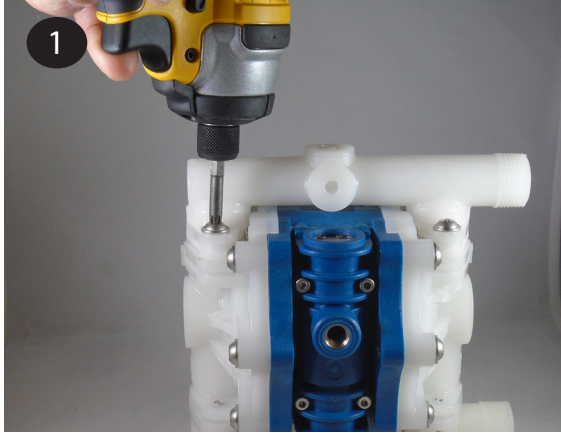

- 2 The discharge seat o-rings, valve seats and valve balls (items 13, 14, & 15) can now be accessed and replaced if needed.

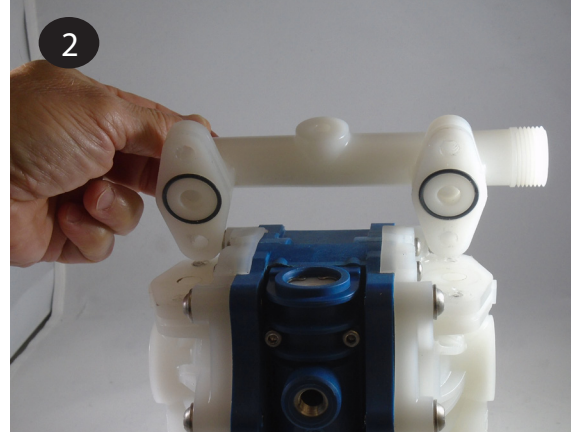

- 3 Repeat the above steps for the suction manifold (item 12). The seat o-rings, valve seats and valve balls (items 13, 14, & 15) are located in the liquid chambers (item 18).

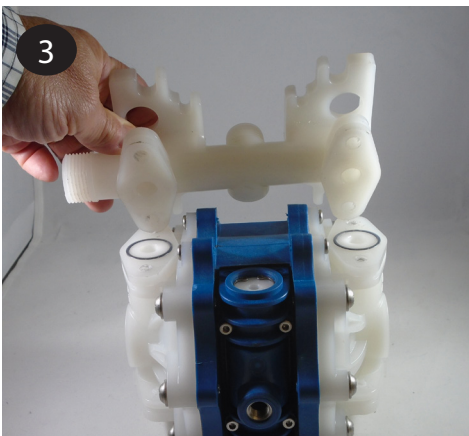

- 4 Remove both liquid chambers by removing the (6) self-threading screws (item 11) using a T30 or T27 Torx bit and (5) button head cap screws (item 17) using a T20 Torx bit. Inspect and replace diaphragms as needed.



- 5 Remove the diaphragms (items 20), begin by loosening the (2) outer plates (item 19) using two 5/8" wrenches. Use 6-sided sockets or wrenches to prevent damage to the hex portion of the outer plate.



6 Remove the outer plate, diaphragm(s), and inner plate (items 19, 20, 21, 22, & 23) from the side that is loosened. Pull or push the shaft (item 27) and remaining plates and diaphragms out of the center section. If pulling, it may be easier to grip the diaphragm if it is inverted.

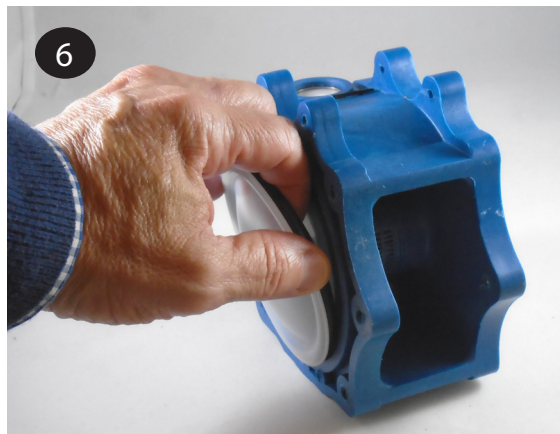
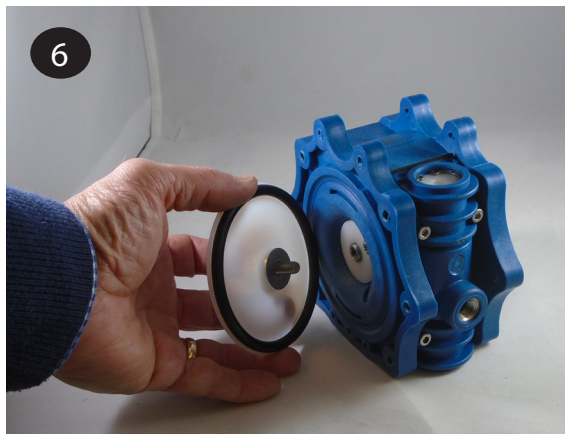

7 The remaining diaphragm (item 20) and plates (items 19 & 23) may be removed from the shaft (item 27) by hand or by placing the shaft in a vise fitted with soft jaws. Use a 6-sided 5/8" wrench to remove the remaining diaphragm and plates. Soft jaws are required to prevent damage to the shaft. A damaged shaft will result in accelerated o-ring wear. Jaws can be fitted with wood, plastic, rubber, or other soft material to prevent shaft damage.

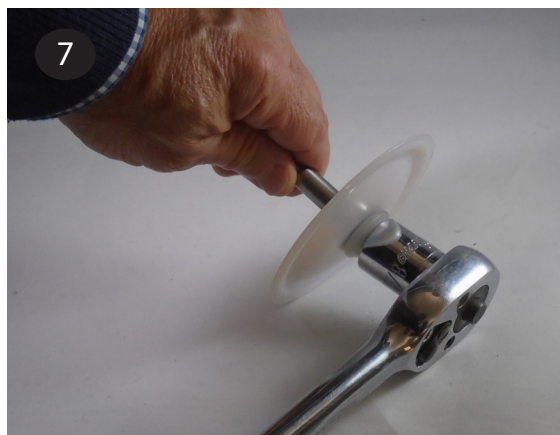

After performing required maintenance, the pump can be reassembled. The pump can also be reassembled using the disassembly instructions in the reverse order as listed above. For detailed assembly instructions, follow steps Wet End Reassembly instructions on next page.

Wet End Reassembly

1 Slide the center hole of one diaphragm (item 20) over the molded in bolt of an outer plate (item 19). For both PTFE and Santoprene™ fitted pumps the outer plate should be on the convex face of the diaphragm as shown.



2 For Santoprene fitted pumps place the inner plate (item 23) over the bolt so that the round groove in the inner plate faces the diaphragm. For PTFE fitted pumps place the small diaphragm o-ring (item 22) into the groove of the diaphragm. Then place the inner plate over the bolt so that the round groove in the inner plate faces the diaphragm.



3 Apply a medium strength thread locker, such as Loctite® 246, to the outer plate (19) bolt threads and shaft (item 27) threads. To ensure thread locker cures quickly, a primer such as Loctite® SF7649 should be used. Thread the shaft onto the outer plate bolt until it is snug.



4 The shaft (item 27) and shaft bushing assembly (items 24, 25 & 26) should retain the lubricant that was factory applied. If they appear dry, apply a light coat of lithium thickened grease. Avoid over lubrication as it can cause decreased performance of the air distribution system.



5 For PTFE fitted pumps place the large diaphragm o-ring (item 21) into the groove in the center section (item 28).

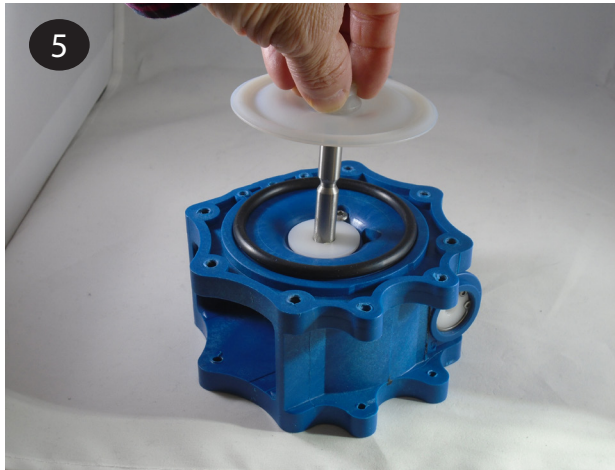

6 Push the shaft (item 27) through the center of the center section (item 28).

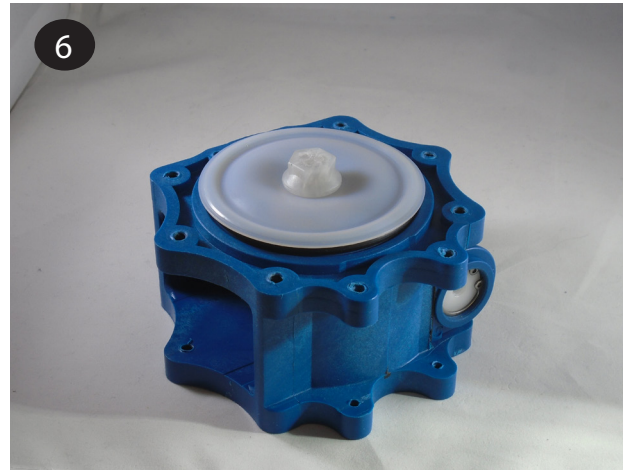

7 The other diaphragm(s) (item 17) and inner/outer plates (items 19 & 23) can be installed onto the opposite end of the shaft (item 27). It may be easier to thread the molded in bolt into the shaft if the diaphragm(s) is inverted on one or both sides. This can be done by hand.

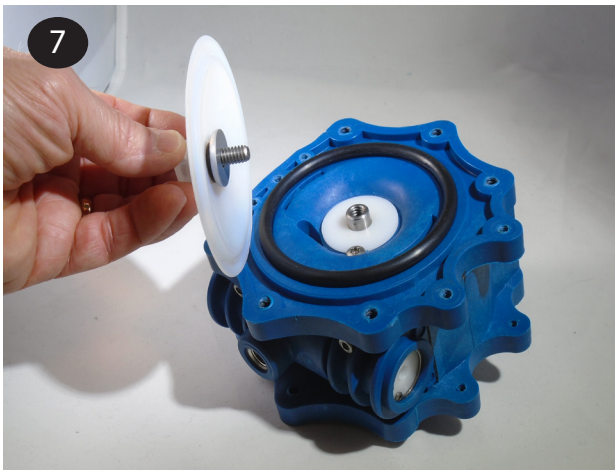

8 Tighten and torque the outer plates (item 19) to 40 in-lbs (4.5 N-m).



9 Install the liquid chambers (item 18) by placing one side over the diaphragm. Start all 6 screws (item 11) before tightening and torquing. Torque all fasteners in a star pattern to 50 in-lbs (5.6 N-m). Start all 5 screws (item 17) before tightening and Torquing. Torque all screws in a X Pattern to 30 in-lbs (3.4 N-m). Repeat to install the second liquid chamber. Ensure both chambers are orientated the same and that the inlet and outlet ports are vertical when facing the front of the pump.

IMPORTANT: Threads must line up or stripping of threads can occur.

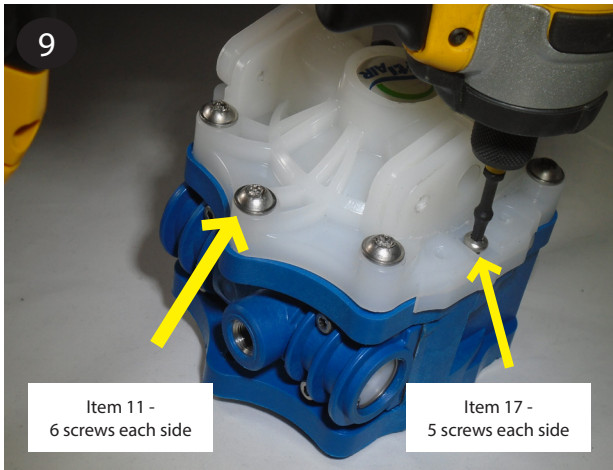

10 Flip the pump upside down and drop the suction valve balls (item 15) into the liquid chambers (item 18) ball cages.

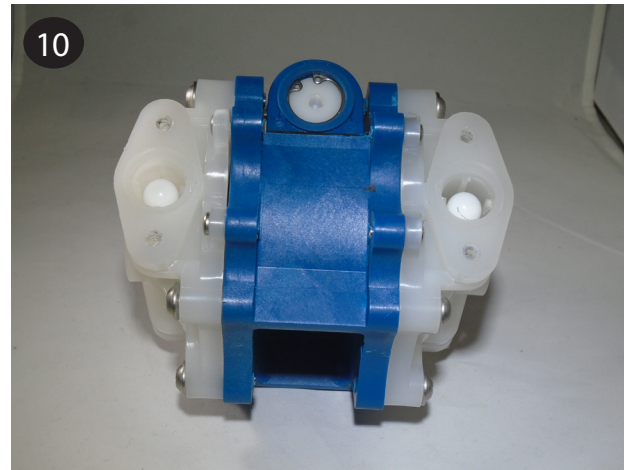

11 Place the valve seats (item 14) into the seat bore then the valve seat o-rings (item 13) into the groove that is formed by the seats.

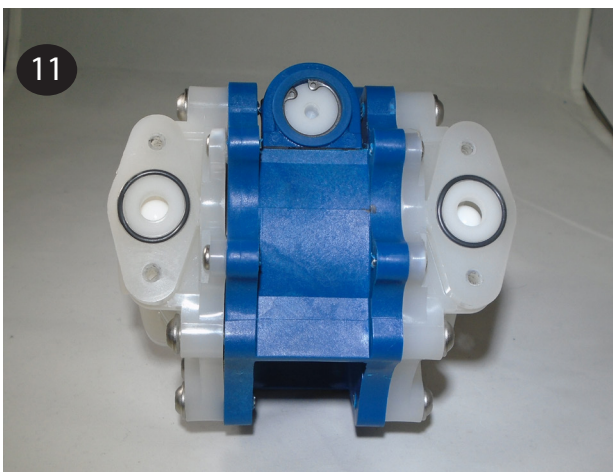

12 Place the suction manifold (item 12) atop the pump. Tighten and torque the suction manifold bolts (item 11) in an "X" pattern. Torque to 50 in-lbs (5.6 N-m)

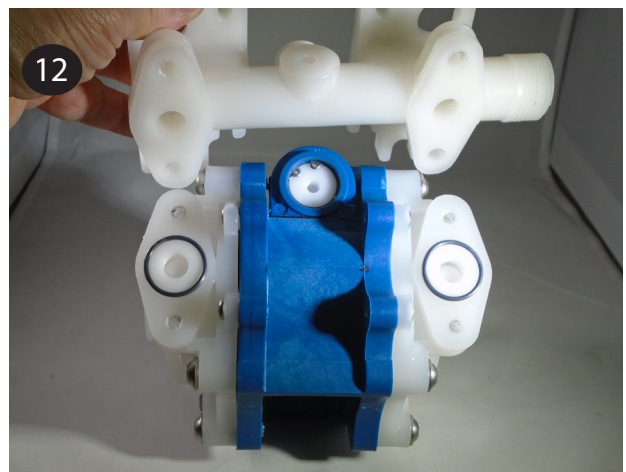

13 Stand the pump upright onto the suction manifold feet (item 12). Place the valve balls (item 15), valve seats (item 14), and seat o-rings (item 13) into the discharge manifold (item 16) in the same order as the suction side was done in step 11. Place the discharge manifold atop the pump, tighten, and torque the discharge manifold bolts (item 11) in an "X" pattern. Torque to 50 in-lbs (5.6 N-m).

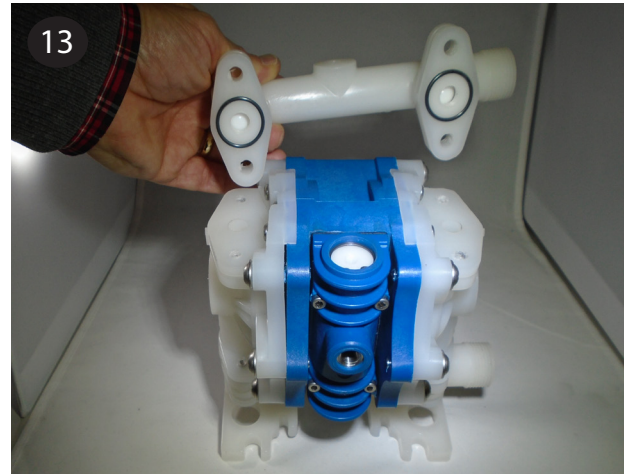

Air End Servicing (Installing Air End Kit)

• Follow steps 1 – 6 in the Wet End Servicing disassembly section to access the shaft bushings (items 24), then follow steps below.

Shaft & Bushing Replacement

1 To replace the shaft bushings (item 24), carefully remove the old bushings. Remove the bushing hold down screw (item 17) using a T20 Torx bit. Use 1 or 2 flat head screw drivers to pry the bushing out. Repeat for the other side.

2 Bushings (item 24) are supplied with both o-rings (items 25 & 26). Lubricate the o-rings (item 25) with a compatible lubricant and push it into the bushing (item 28) gland in the center section. Reinstall the bushing hold down screw (item 17).

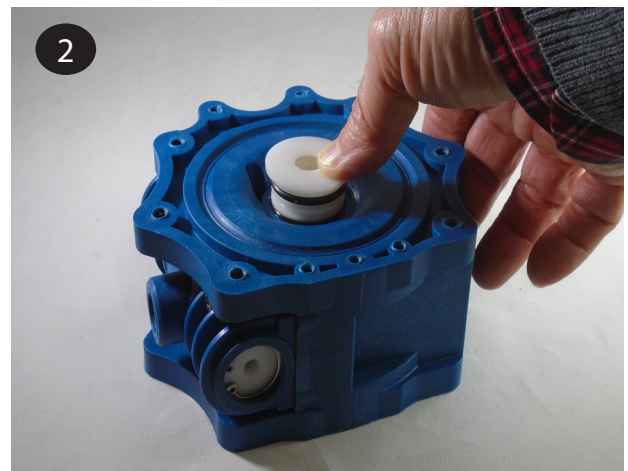

3 If replacing the bushings (item 24), then the muffler felt (NS) should also be replaced prior to replacing the second bushing. It is important when installing the felt that it does not block the air slot. Lubricate the bushing o-rings (item 25) and press it into the open bushing gland. Reinstall the bushing, hold down screw (item 17).



4 Inspect the shaft (item 27) for damage. It is common for shafts to become grooved during service. Grooving is normally caused by carbonized oil and/or abrasive foreign material getting trapped between the seal and the shaft. Over time, deep grooves can form in the shaft. When that occurs, it is recommended that the shaft be replaced.



- After determining if the condition of the shaft is acceptable, follow steps 5 – 13 in the Wet End Servicing – Wet End Reassembly section to rebuild the rest of the pump.

Air Valve O-Ring Replacement

1 Plastic Air Valve. To replace the valve cup (item 6) or valve cup o-rings (item 5) remove the retaining ring (item 7), then pull straight up. The use of an m6 bolt, vise grip, and pry bars may be necessary. See 1 and 1A pictures.

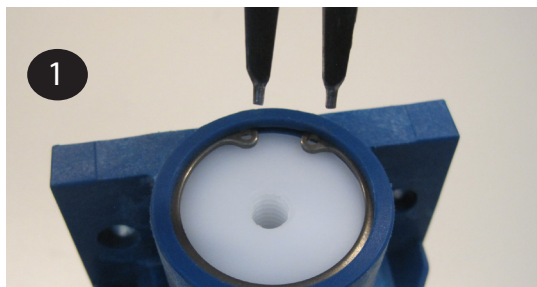

2 Plastic Air Valve - Remove and replace o-rings. Insert cap (item 6) push down until groove for the retaining ring is visible. Make sure to lubricate the o-rings prior to inserting into the valve body with a compatible lubricant.

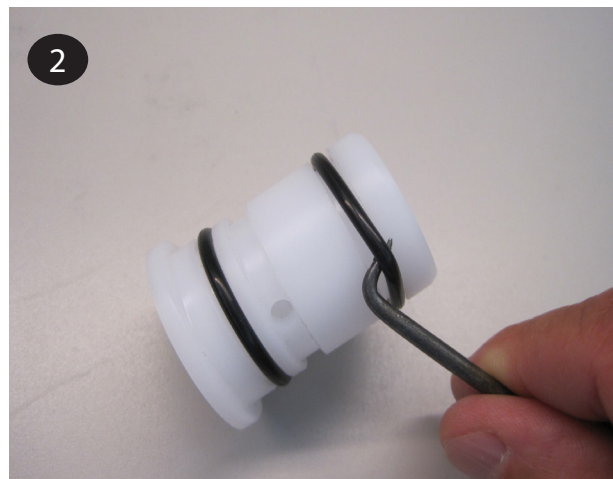

Valve Gasket Replacement

1 Remove the valve body (item 2) by removing the four (4) socket head cap screws (item 1) that attach the valve body to the center section (item 23) with a 3mm hex wrench

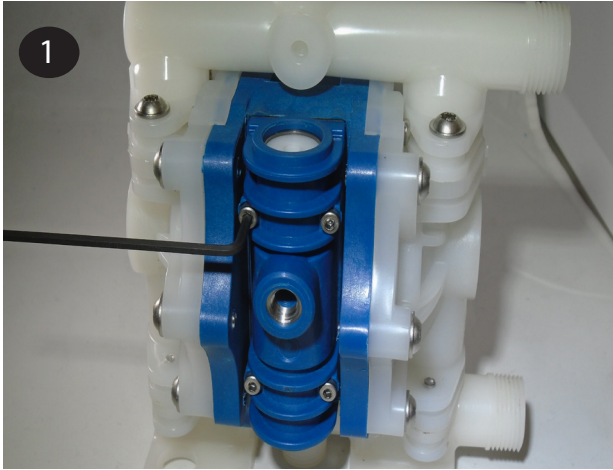

2 Pull the valve body (item 2) off the front of the center section (item 23).

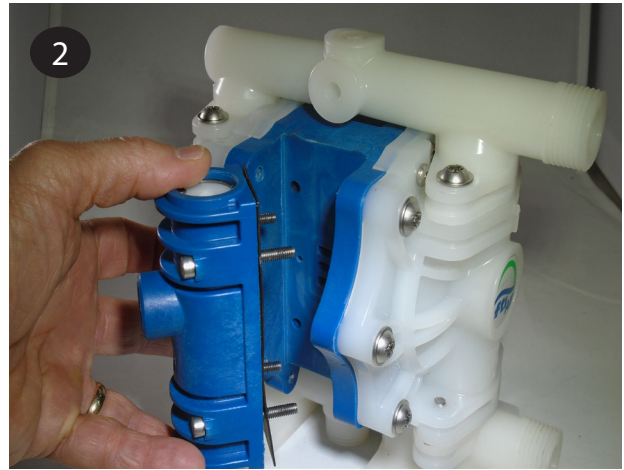

3 Place the new gasket (item 8) on the air valve (item 2) and ensure the slots in the gasket align with the slots in the air valve and valve plate (item 7).

Air Valve Slide, Plate & Gasket Orientation: If the valve plate (item 7) and slide valve (item 6) are removed, ensure they are installed in the proper orientation. The flat face of the slide valve sits in the pocket of the valve carrier (item 5) so that the square cut out on the slide valve faces the smooth polished side of the valve plate

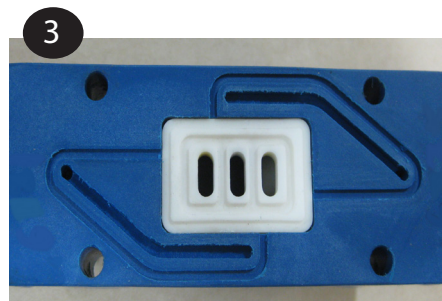
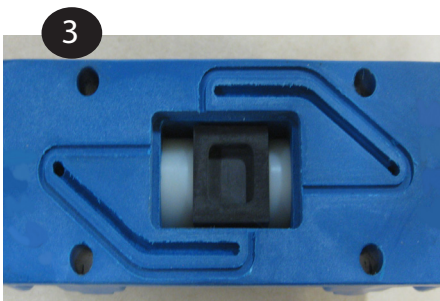

4 Insert the (4) cap screws (item 1) through the valve body and gasket (items 2 & 10) and place onto the center section (item 8). Ensure the slide valve and valve plate (items 8 & 9) are in place and the valve sits flat on the center section.



5 First hand tighten only each cap screw (item 1) until the cap screw head makes contact with the valve body. Torque the cap screws in an "X" pattern. Do not exceed 15 in-lbs (1.7 N-m).

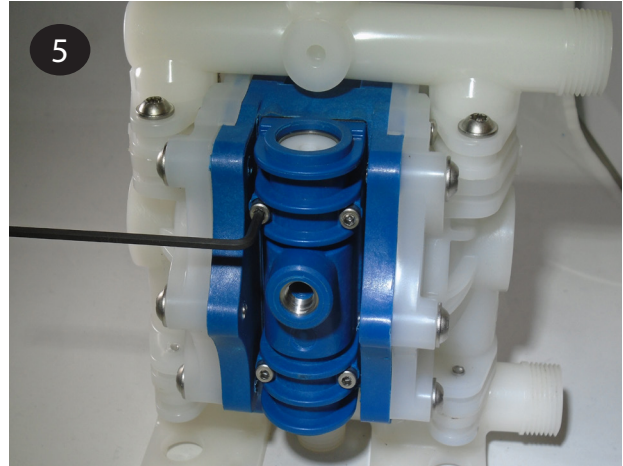

Replacement Air Valve Kit Installation

1. Remove the valve that is to be replaced by removing the (4) socket head cap screws with a 3mm hex wrench that attaches the valve body to the center section.
 2. Save the (4) cap screws (item 1). All other valve components can be discarded.
 3. Remove the packing tape that holds the air valve components in place during shipping.
- Follow steps 3 – 5 in the Valve Gasket section of Air End Servicing above.

Exploded View & Spare Parts List

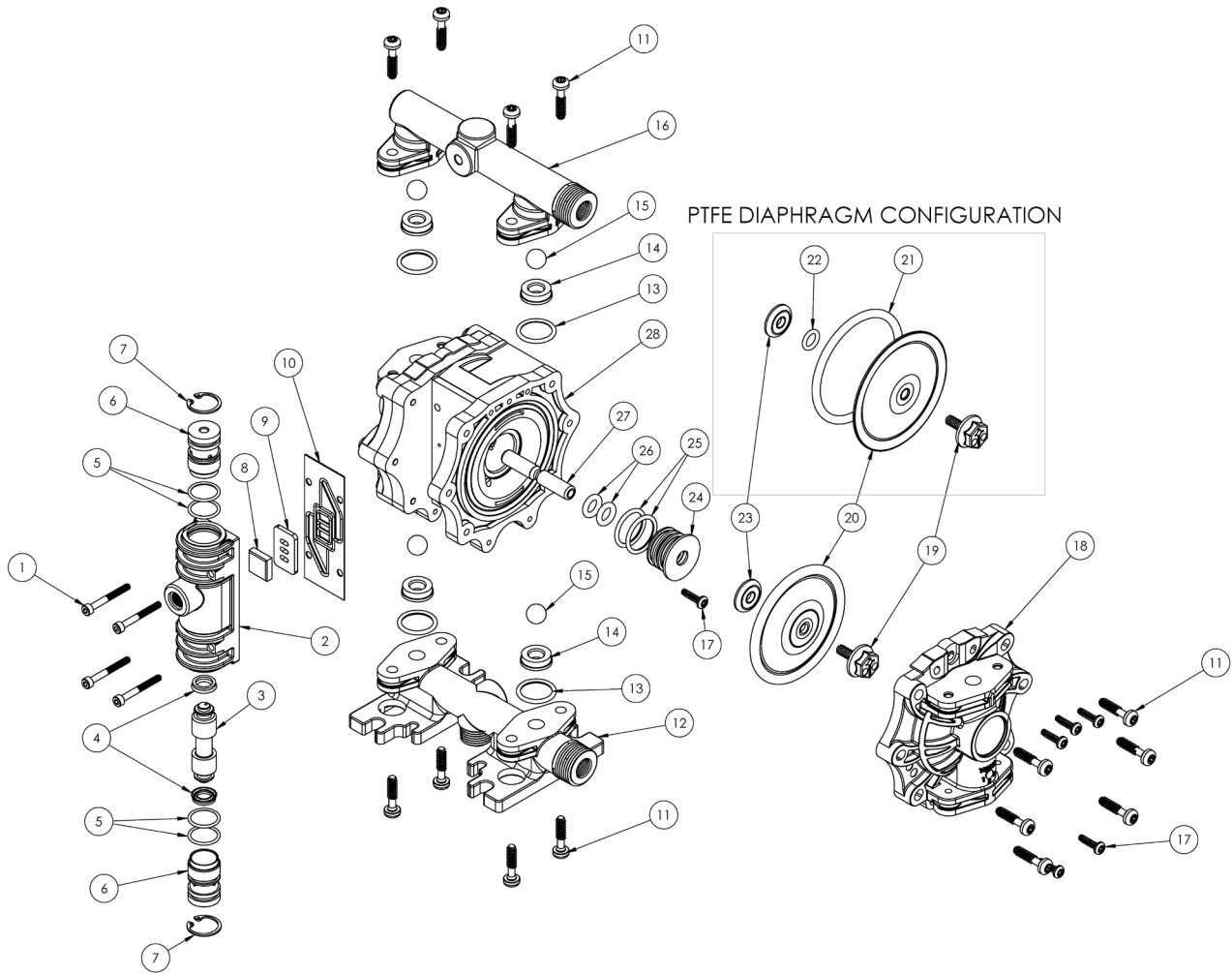

ITEM	DESCRIPTION	PART NO.	ATEX PART NO.	QTY	KIT
1	CAP SCREW, SOCKET HD M4-0.7X35MM SSSL	109724	-	4	-
2	VALVE BODY, FNPT GLASS FIBER REINFORCED PP (GFRPP) FT025	109248	-	1	V1
	VALVE BODY, FNPT CARBON FILLED ACETAL (CFPOMC) FT025	-	109248-1	1	V2
	VALVE BODY, FBSPT GLASS FIBER REINFORCED PP (GFRPP) FT025	109248-2	-	1	V1
	VALVE BODY, FBSPT CARBON FILLED ACETAL (CFPOMC) FT025	-	109248-3	1	V2
3	VALVE CARRIER W/CUP SEALS (ITEM 4) FT025	111797	-	1	V1/V2
4	CUP SEAL FT025	109972	-	2	V1/V2
5	VALVE CAP O-RING, BUNA FT025 & FT05	109877	-	4	A1/V1/V2
6	VALVE CAP, DELRIN W/O-RINGS (ITEM 5) FT025 & FT05	111796	-	2	V1/V2
7	RETAINING RING, HO-81 SSSL FT025 & FT05	109649	-	2	V1/V2
8	SLIDE VALVE FT025	109256	-	1	V1/V2
9	VALVE PLATE FT025	109260	-	1	V1/V2
10	GASKET, AIR VALVE FT025	109264	-	1	A1/V1/V2
11	TORX HD, DELTA P60-2.14 X 25MM	109764	-	20	-

ITEM	DESCRIPTION	PART NO.	ATEX PART NO.	QTY	KIT
12	MANIFOLD, SUCTION PP UNIVERSAL NPT/BSPT FT025	SEE MANIFOLD TABLE			
	MANIFOLD, SUCTION PVDF UNIVERSAL NPT/BSPT FT025	SEE MANIFOLD TABLE			
	MANIFOLD, SUCTION CFPP UNIVERSAL NPT/BSPT FT025	-	109116-3	1	-
13	O-RING, VALVE SEAT, SANTOPRENE (RED) FT025	109733	-	4	W
	O-RING, VALVE SEAT, FEP/FKM FT025	109325	-	4	
14	VALVE SEAT, PP FT025	109223	-	4	W
	VALVE SEAT, PVDF FT025	109223-1	-	4	
	VALVE SEAT, CARBON FILLED PTFE (CFPTFE) FT025		109223-2	4	
15	VALVE BALL, PTFE (WHITE), FDA FT025	109198	-	4	W
	VALVE BALL, SANTOPRENE (RED) FT025	109198-1	-	4	
16	MANIFOLD, DISCHARGE PP UNIVERSAL NPT/BSPT FT025	SEE MANIFOLD TABLE			
	MANIFOLD, DISCHARGE PVDF UNIVERSAL NPT/BSPT FT025	SEE MANIFOLD TABLE			
	MANIFOLD, DISCHARGE CFPP UNIVERSAL NPT/BSPT FT025	-	109131-3	1	-
17	SCREW, PLASTITE #8X5/8	109858	-	12	-
18	CHAMBER, LIQUID PP FT025 W/FTI LOGO	109767-22	-	2	-
	CHAMBER, LIQUID PVDF FT025 W/FTI LOGO	109767-23	-	2	-
	CHAMBER, LIQUID CFPP FT025 W/FTI LOGO	-	109767-24	2	-
19	PLATE, OUTER PP FT025	109152-1	-	2	-
	PLATE, OUTER PVDF FT025	109152-2	-	2	-
	PLATE, OUTER CFPP FT025	-	109152-3	2	-
20	DIAPHRAGM, PTFE (WHITE) FT025	109181	-	2	W
	DIAPHRAGM, SANTOPRENE (RED) FT025	109465	-	2	
21	PTFE DIAPHRAGM. LARGE BACKUP O-RING, NEOPRENE FT025	109725	-	2	W
22	PTFE DIAPHRAGM, SMALL BACKUP O-RING, NEOPRENE FT025	109727	-	2	W
23	PLATE, INNER, AL FT025	109167-3	-	2	-
	PLATE, INNER, SSSL FT025	109167-2	-	2	-
24	BUSHING W/O-RINGS (ITEMS 25 & 26) FT025	111795	-	2	A1
25	O-RING, BUSHING OD BUNA FT025	111738	-	4	A1
26	O-RING, BUSHING ID FT025	111737	-	4	A1
27	SHAFT, SS FT025	109172	-	1	-
28	CENTER SECTION, PP FT025	109148	-	1	-
	CENTER SECTION, CFPP FT025	-	109148-1	1	-
29	PIPE PLUG, PP 1/4" NPT/BSPT	SEE MANIFOLD TABLE			
	PIPE PLUG, PVDF 1/4" NPT/BSPT	SEE MANIFOLD TABLE			
NS	GROUNDING LUG	-	109698	1	-
NS	MUFFLER FELT	109072	-	1	-

NS - Not Shown

FT025P, FT025C, & FT025V Maximum Torque Settings*	
Item #	Torque
1	1.7 N-m (15 in-lbs)
11	5.6 N-m (50 in-lbs)
17	3.4 N-m (30 in-lbs)
19	4.5 N-m (40 in-lbs)
Asterisk () from the exploded view diagram indicates fasteners to be torqued.	

FT025 Kits		
Kit Key	Description	Part No.
W	PARTS SUPPLIED IN A WET SIDE KIT	-
A1	PARTS SUPPLIED IN AIR END KIT	109815
V1	PARTS SUPPLIED IN GFPP REPLACEMENT VALVE KIT	109816
V2	PARTS SUPPLIED IN CF POMC REPLACEMENT VALVE KIT	109816-1

SUCTION MANIFOLD (ITEM 12)								
BEGINNING OF MODEL NUMBER	LAST 2 DIGITS OF MODEL NUMBER (BEFORE SPECIALTY CODE FIELD)							
	N1 (END)		N2 (CH)		N3 (CV)		N4 (CV & END)	
	PART NO.	QTY	PART NO.	QTY	PART NO.	QTY	PART NO.	QTY
FT025P (POLYPROPYLENE)	109116-1	1	109746	1	109746-1	1	109746-1	1
ITEM 29 PP PIPE PLUG (NS)	N/A	0	109754	1	109754	1	109754	1
FT025V (PVDF)	109116-2	1	109746-2	1	109746-3	1	109746-3	1
ITEM 29 PVDF PIPE PLUG (NS)	N/A	0	109755	1	109755	1	109755	1

DISCHARGE MANIFOLD (ITEM 16)								
BEGINNING OF MODEL NUMBER	LAST 2 DIGITS OF MODEL NUMBER (BEFORE SPECIALTY CODE FIELD)							
	N1 (END)		N2 (CH)		N3 (CV)		N4 (CV & END)	
	PART NO.	QTY	PART NO.	QTY	PART NO.	QTY	PART NO.	QTY
FT025P (POLYPROPYLENE)	109131-1	1	109747	1	109747-1	1	109131-1	1
ITEM 29 PP PIPE PLUG (NS)	N/A	0	109754	1	109754	1	N/A	0
FT025V (PVDF)	109131-2	1	109747-2	1	109747-3	1	109131-2	1
ITEM 29 PVDF PIPE PLUG (NS)	N/A	0	109755	1	109755	1	N/A	0

Optional Porting Locations: END=Standard Porting, CH=Center Horizontal, CV=Center Vertical, CV & END= Center Vertical Suction & END discharge.

Warranty



FTI Air A Division of Finish Thompson, Inc (manufacturer) warrants this pump product to be free of defects in materials and workmanship for a period of five years from date of purchase by original purchaser. If a warranted defect, which is determined by manufacturer's inspection, occurs within this period, it will be repaired or replaced at the manufacturer's option, provided (1) the product is submitted with proof of purchase date and (2) transportation charges are prepaid to the manufacturer.

Liability under this warranty is expressly limited to repairing or replacing the product or parts thereof and is in lieu of any other warranties, either expressed or implied. This warranty does not apply to normal wear of the product or components. This warranty does not apply to products or parts broken due to, in whole or in part, accident, overload, abuse, chemical attack, tampering, or alteration. The warranty does not apply to any other equipment used or purchased in combination with this product. The manufacturer accepts no responsibility for product damage or personal injuries sustained when the product is modified in any way. If this warranty does not apply, the purchaser shall bear all cost for labor, material and transportation.

Manufacturer shall not be liable for incidental or consequential damages including, but not limited to process down time, transportation costs, costs associated with replacement or substitution products, labor costs, product installation or removal costs, or loss of profit. In any and all events, manufacturer's liability shall not exceed the purchase price of the product and/or accessories



FINISH THOMPSON INC. - HEADQUARTERS

921 Greengarden Road | Erie, PA 16501
800.934.9384 | ph 814.455.4478 | fx 814.455.8518
email fti@finishthompson.com

FINISH THOMPSON GMBH - EUROPE CENTER

Otto-Hahn-Strasse 16 | Maintal, D-63477 Germany
49 (0)6181-90878-0 | fx 49 (0)6181-90878-18
email fti@finishthompson.com