

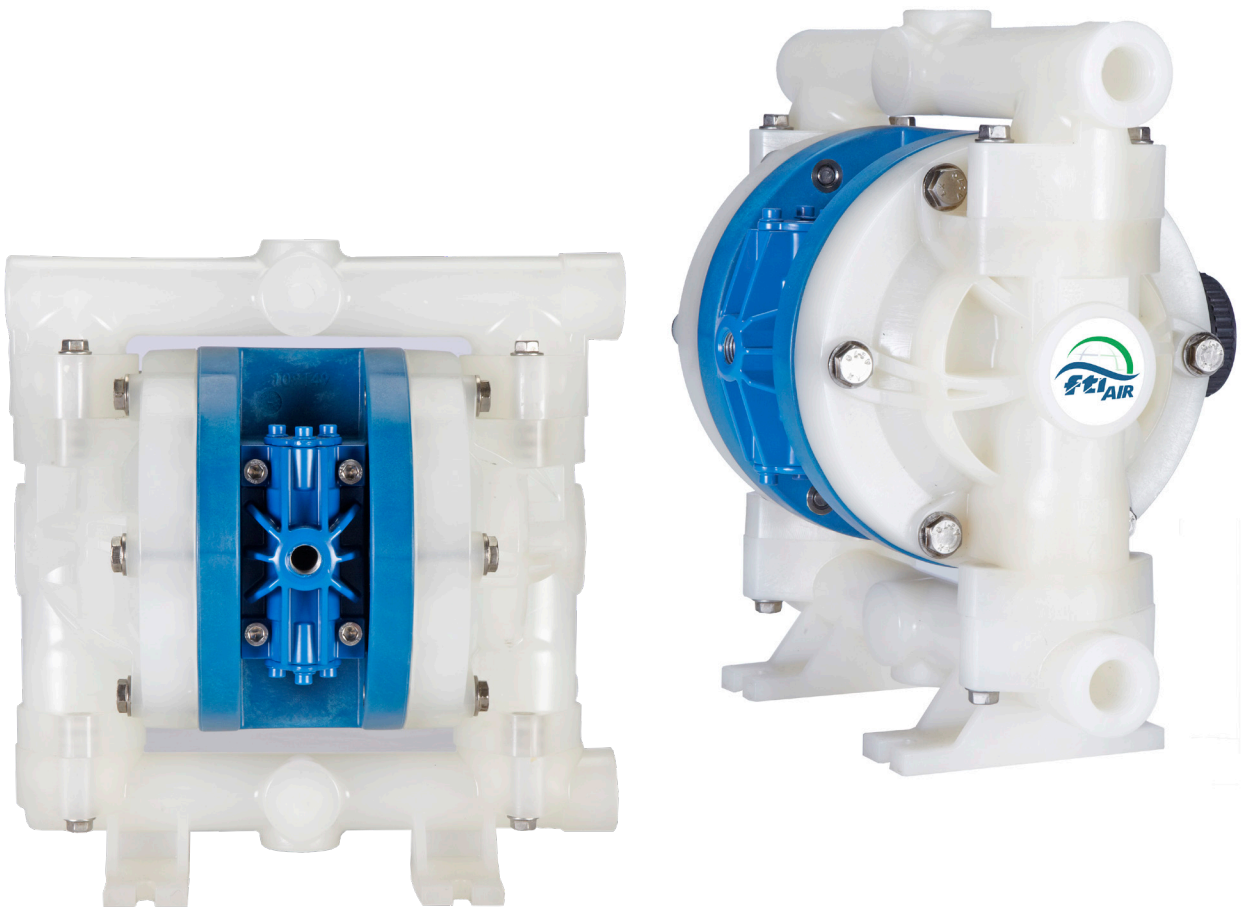

FTI AIR AODD MODELS FT05P, FT05V, & FT05C

Assembly, Installation, & Operation Manual

P/N 109684 R11



Record your Model and Serial Number here.

MODEL NUMBER _____

SERIAL NUMBER _____



A DIVISION OF FINISH THOMPSON INC.
921 Greengarden Rd • Erie, PA 16501 USA
Ph: 814-455-4478 • Fax: 814-455-8518
www.ftiair.com

EU Declaration of Conformity



FTI Air hereby declares that the following machine(s) fully comply with the applicable health and safety requirements as specified by the EC Directives listed. The complete product complies with the provisions of the EC Directive on machinery safety.

This declaration is valid provided that the devices are fully assembled and no modifications are made to these devices.

Type of Device:

Air Operated Double Diaphragm Pumps

Models:

FT025P, FT025V, FT025C, FT05P, FT05V, FT05A, FT05S,
FT10P, FT10V, FT10A, FT10S, FT15P, FT15V, FT15A, FT15S, FT15ZP, FT15ZV, FT15ZA, FT15ZS,
FT20P, FT20V, FT20A, FT20S, FT30A & FT30S

EC Directives:

Machinery Safety (2006/42/EC)

Applied Harmonized Standards:

EN ISO 12100

Manufacturer:

FTI Air A Division of Finish Thompson, Inc.
921 Greengarden Road
Erie, Pennsylvania 16501-1591 U.S.A

Signed,

President

23 May 2019

Person(s) Authorized to Compile Technical File: FTI Air GmbH
Otto-Hahn-Strasse 16
Maintal, D-63477 DEU
Telephone: 49 (0)6181-90878-0

EU Declaration of Conformity

Manufactured by:

Finish Thompson, Inc.
921 Greengarden Road
Erie, Pennsylvania 16501 U.S.A.
Phone: 1-(814)-455-4478
Fax 1-(814)-455-8518
Email: fti@finishthompson.com
Web: www.finishthompson.com



II 2GD
Ex h IIC T6 Gb
Ex h IIIC T6 Db
FTZU 16 ATEX A473-16

This declaration applies to **FTI Air ATEX Series** AODD pumps, being designated by the letter -A- in the model number, and only manufactured out of carbon fiber filled PP designated by the model number FT05C, with metallic or carbon fiber filled non-wetted parts designated by the letters -AA- or -CD- within the model number. Pumps and their model numbers may also contain different combinations of diaphragms, balls, seats, o-rings, port connections, and other options.

Example Model Numbers: FT05C-CD-2TPC-B1-A, FT05C-CA-FFPF-B1-A

Finish Thompson declares under our sole responsibility that the product listed below conforms to the relevant provisions of EU directive 2014/34/EU of 26 February 2014 for equipment and protective systems intended for use in potentially explosive atmospheres, and is certified for safe use in Group II category 2 areas.

This product has used the following harmonized standards to verify conformance:

Non-electrical equipment for potentially explosive atmospheres: EN ISO 80079-36:2016
Basic Methods and Requirements.

Non-electrical equipment intended for use in potentially explosive atmospheres: EN ISO 80079-37:2016
Protection by construction safety "ch" and control of ignition source "bh".

This product must not be used in areas other than specified above. If in doubt consult an authorized distributor, or refer to the manufacturer Finish Thompson.

Approved by:

Date: 12/03/2020

Table of Contents

Important Information - READ ME FIRST

Export Regulation Notice	5
Chemical Reaction Disclaimer	5
Safety Precautions	5-6

Pump Specifications

Materials Profiles.....	7
Model Number Explanation & Example Part Numbers.....	8
Dimensional Drawing.....	8
Performance Curve.....	9
Technical Specifications	9

Installation/Operation

Installation Drawing.....	10
Precautions.....	10-11
Troubleshooting.....	11

Maintenance

Recommended Tools	11
Wet End Servicing	11
Disassembly	12-13
Reassembly	14-17
Air End Servicing	17
Shaft Bushing & O-ring Replacement.....	17-18
Air Valve O-ring Replacement.....	18-19
Valve & Muffler Gasket Replacement.....	19-20
Air Valve Slide, Plate, & Gasket Orientation.....	20
Replacement Air Valve Kit Installation.....	21
Exploded View	21
Spare Parts List.....	21-24

Warranty	25
-----------------------	-----------

Important Information- Read Me first

IMPORTANT NOTICE

U.S. Export Administration Regulations, pursuant to ECCN 2B350, prohibit the export or re-export to certain enumerated countries of air operated double diaphragm pumps in which all wetted materials are constructed from fluoropolymers without first applying for and obtaining a license from the U.S. Bureau of Industry and Security(BIS). This affects all FTI AIR pumps constructed from PVDF with PTFE balls and diaphragms. Please contact the BIS (www.bis.doc.gov) or FTI Air with questions regarding the Regulations or a list of the countries to which they apply.

Chemical Reaction Disclaimer

The user must exercise primary responsibility in selecting the product's materials of construction which are compatible with the fluid(s) that come(s) in contact with the product. The user may consult FTI Air (manufacturer) and a manufacturer's representative/distributor agent to seek a recommendation of the product's material of construction that offers the optimum available chemical compatibility.

However neither manufacturer nor agent shall be liable for product damage or failure, injuries, or any other damage or loss arising out of a reaction, interaction or any chemical effect that occurs between the materials of the product's construction and fluids that come into contact with the product's components.

Unpacking & Inspection

Unpack the pump and examine for any signs of shipping damage. If damage is detected, save the packaging and notify the carrier immediately.

To install the pump, follow the installation instructions provided.

Safety Precautions for ATEX Pumps

⚠ Warning: READ THIS SUPPLEMENTAL INSERT COMPLETELY BEFORE INSTALLING AND OPERATING THIS PUMP. FAILURE TO FOLLOW THESE PRECAUTIONS CAN RESULT IN SERIOUS INJURY OR DEATH.

⚠ WARNING: Static sparking can cause explosion. When operating in a hazardous area or pumping a hazardous fluid, the pump's grounding screw and entire pump system must be grounded to earth to prevent static discharge. This includes but is not limited to pipes, hoses, tanks, containers, valves, etc. Before operating the pump, ensure the electrical continuity throughout the pumping system and earth ground is 1 Ohm or less. If it is greater than 1 Ohm, re- check all grounding connections.

⚠ WARNING: Static sparking can cause explosion. Excessive fluid flow rates and improper tank filling methods can produce static electricity causing an explosion. Ensure safe fluid velocities and tank filling procedures in compliance with EN 13463-1 and CLC/TR 50404.

⚠ WARNING: Vibrations from operation may cause mounting surfaces and connections to loosen and generate a spark. Ensure the pump and connections are securely mounted and fastened prior to each operation.

⚠ WARNING: Do not exceed minimum and maximum temperature limits of pump components. A table of temperature limits is provided in the "Pump Data" section of the manual.

⚠ WARNING: Prior to operating, check pump for any worn o-rings, gaskets, or seals. Any leaking or damaged o-rings, gaskets, or seals must be repaired or replaced immediately.

⚠ WARNING: Do not exceed maximum pressure stated on the pump serial number sticker.

⚠ WARNING: Pump exhaust may be loud and contain particles. Wear appropriate ear and eye protection. In the event of a diaphragm rupture material can be forced out of the air exhaust muffler. If product is hazardous or toxic, pipe exhaust to appropriate safe area.

⚠ WARNING: Pump must be cleaned on a regular basis to avoid dust buildup greater than 5mm.

⚠ WARNING: The surface temperature of the pump depends upon the temperature of the fluid that is being pumped. The chart below lists different fluid temperatures and the corresponding pump surface temperatures, which determine the Temperature Class when used in a hazardous area.

Fluid Temperature	Maximum Surface Temperature	Temperature Class	Maxium Allowable Surface Temperature
180° F (82° C)	180° F (82° C)	T6	85° C

Safety Precautions

⚠ WARNING: Never use a natural polypropylene or natural PVDF pump with flammable or combustible fluids/materials.

⚠ WARNING: FTI Air maximum temperature limits are based upon the material's mechanical stress only. Maximum temperature is application dependent. Consult a chemical resistance guide or the chemical manufacturer for chemical compatibility and temperature limits.

⚠ WARNING: Chemical Hazard. This pump is used for transferring many types of potentially dangerous chemicals. Always wear protective clothing, eye protection and follow standard safety procedures when handling corrosive or personally harmful materials. Proper procedures should be followed for draining and decontaminating the pump before disassembly and inspection of the pump. There may be small quantities of chemicals present during inspection.

⚠ WARNING: Hot surfaces. FTI Air pumps are capable of handling liquids with temperatures as high as 220°F (104°C). This may cause the outer areas of the pump to become hot as well and could cause burns.

⚠ WARNING: If a diaphragm rupture occurs, material being pumped may be forced out of the air exhaust. Proper care should be taken, always wear protective clothing, eye protection & follow standard safety procedures.

⚠ WARNING: When pumping hazardous liquids, or operating the pump in an enclosed room, it is important to pipe the exhaust air to a safe area.

⚠ WARNING: For polypropylene or PVDF pumps do not exceed 100 psig (6.9 bar) air supply & 120 psig (8.3 bar) for aluminum and stainless steel.

⚠ CAUTION: Before attaching air supply to pump to make sure all airline debris is clear. It is recommended to use a minimum 5μ (micron) air filter before the air valve.

⚠ CAUTION: Do not over-tighten the air inlet fitting or muffler. Too much torque could damage the air valve or muffler plate.

⚠ CAUTION: Before maintenance or repair, close the compressed air line supply valve, bleed the pressure and disconnect air line from the pump. Discharge line may also be pressurized. Any pressure must be relieved prior to servicing. Remove suction / discharge lines & drain the pump.

⚠ CAUTION: If pump is used with materials that tend to solidify or settle, the pump should be flushed after each use to prevent damage.

⚠ CAUTION: Use only genuine FTI Air replacement parts to assure compatibility & longest service life.

⚠ CAUTION: Check the temperature limits for all wetted components when choosing pump materials. See table on page 7.

⚠ EXPLOSION HAZARD! FTI Air pumps with standard materials of construction should not be used with halogenated hydrocarbons. Halogenated hydrocarbon solvents can cause explosion when used with aluminum components in a closed (pressurized) system. FTI Air pumps with standard materials of construction contain aluminum components and will be affected by halogenated hydrocarbon solvents.

1-1-1 Trichloroethane and Methylene Chloride are the most common halogenated hydrocarbons. However, other halogenated hydrocarbon solvents are suspect if used either as part of paint or adhesive formulation, or for clean-up flushing. For applications that may involve halogenated hydrocarbons, contact FTI Air to discuss the availability of alternative pump materials of construction.

Material Profiles

Material	Chemical Composition	Description	Operating Temperature		Relative Cost
			Minimum	Maximum	
Polypropylene	Pure Polypropylene	Thermoplastic that is resistant to alkali and strong acids.	32°F (0°C)	158°F (70°C)	\$
Conductive Polypropylene	Carbon filled Polypropylene	Thermoplastic that is resistant to alkali and strong acids and conductive.	32°F (0°C)	180°F (82°C)	\$\$
PVDF	Pure Polyvinylidene Fluoride	Strong fluoropolymer with excellent chemical resistance.	10°F (-12°C)	220°F (104°C)	\$\$\$
Stainless Steel	316 Stainless Steel	Excellent chemical resistance, high tensile and impact strength, abrasion resistant.	Limited by other materials used		\$\$
Aluminum	ADC 12, LM24, LM25	Moderate chemical resistance with good impact strength and abrasion resistance.	Limited by other materials used		\$
Buna	Acrylonitrile-butadiene Rubber	General purpose elastomer. Resistant to oil, water, solvent, and hydraulic fluid.	10°F (-12°C)	190°F (88°C)	\$
EPDM	Ethylene Propylene Diene Rubber	Good resistance to mild acids, detergents, alkalis, ketones, and alcohols.	-40°F (-40°C)	250°F (121°C)	\$
FKM	Fluorocarbon Rubber	Good chemical resistance and high temperature properties. Resistant to most acids, aliphatic, aromatic, and halogenated hydrocarbons, oils, grease, and fuels.	-40°F (-40°C)	350°F (177°C)	\$\$
Neoprene	Chloroprene Rubber	General purpose elastomer with good resistance to moderate chemicals, oils, grease, solvents, and some refrigerants.	0°F (-18°C)	212°F (100°C)	\$
Santoprene™	Fully cured EPDM rubber particles encapsulated in a polypropylene (PP) matrix	Thermoplastic elastomer with good abrasion resistance with chemical resistance to a wide range of solvents and chemicals. Injection molded with no fabric layer.	-40°F (-40°C)	225°F (107°C)	\$
HytreI®	Thermoplastic polyester elastomer	Combines resistance and flexibility of elastomers with the strength of plastics. Resistant to acids, bases, amines, and glycols. Injection molded with no fabric layer.	-20°F (-29°C)	220°F (104°C)	\$
Polyurethane	Polyester Urethane	Thermoplastic that exhibits excellent abrasion resistance. Injection molded with no fabric layer.	32°F (0°C)	150°F (66°C)	\$
PTFE	Polytetrafluoroethylene	Chemically inert. Resistant to a wide range of chemicals.	40°F (4°C)	225°F (107°C)	\$\$
FEP	Fluorinated Ethylene Propylene	Similar to PTFE in composition and chemical resistance. Used to encapsulate FKM o-rings for superior chemical resistance.	40°F (4°C)	225°F (107°C)	\$\$

Santoprene™ is a registered tradename of Exxon Mobil Corp.

HytreI® is a registered tradename of Dupont™

Model Number Explanation & Example Part Numbers

PART #	XX	XX	X	-	X	X	-	X	X	X	-	X	X	-	X
	Series	Pump Size	Wetted Material		Non-wetted Material	Air Valve Material		Diaphragm Material	Check Valve Ball	Check Valve Seat		Seat O-ring	Connection	Porting Location	Specials

Series*

FT - Pump End
FW - Wet End

Pump Size*

05 - 1/2"

Wetted Materials*

P - Polypropylene
C - Conductive polypropylene**
V - PVDF

Non-wetted Materials

P - GFRPP
C - Conductive polypropylene**

Air Valve Materials

A - Aluminum**
P - GFRPP
D - Conductive acetal**

Diaphragm Materials*

N - Neoprene
B - Buna-N, FDA
E - EPDM
F - FKM
R - Santoprene
H - Hytel
U - Polyurethane
1 - PTFE/Neoprene
2 - PTFE/Santoprene
3 - PTFE/BUNA, FDA
4 - PTFE/Santoprene, FDA
5 - Santoprene, FDA
6 - Hytel, FDA

Check Valve Ball Materials*

N - Neoprene
B - Buna-N
E - EPDM
S - 316SS, FDA
W - Weighted PTFE, FDA
F - FKM
R - Santoprene
T - PTFE, FDA
5 - Santoprene, FDA

Check Valve Seat Materials*

P - Polypropylene, FDA
V - PVDF

Check Valve Seat O-Ring Materials*

B - Buna-N
F - FKM
R - Santoprene
U - Polyurethane
C - FEP/FKM, FDA

Connection

N - FNPT
B - FBSP

Porting Location

1 - End (standard)
2 - Center horizontal
3 - Center vertical
4 - Center vertical suction & end discharge

Specials

M1 - Metal Muffler
K1 - PP drum pump kit
A - ATEX
M2 - Oversize Metal Muffler
K2 - PVDF drum pump kit
P1 - Halogenated hydro-carbon compatible

*Required for wet end

**Required for ATEX

Example Pump P/N's: FT05P-PP-RRPR-N1, FT05P-PA-BBPB-N1, FT05V-PP-1TVC-N2 & FT05V-PA-FFVF-B1

Example Wet End P/N's: FW05P-RRPR, FW05P-BBPB, FW05V-1TVC & FW05V-FFVF

Dimensional Drawing

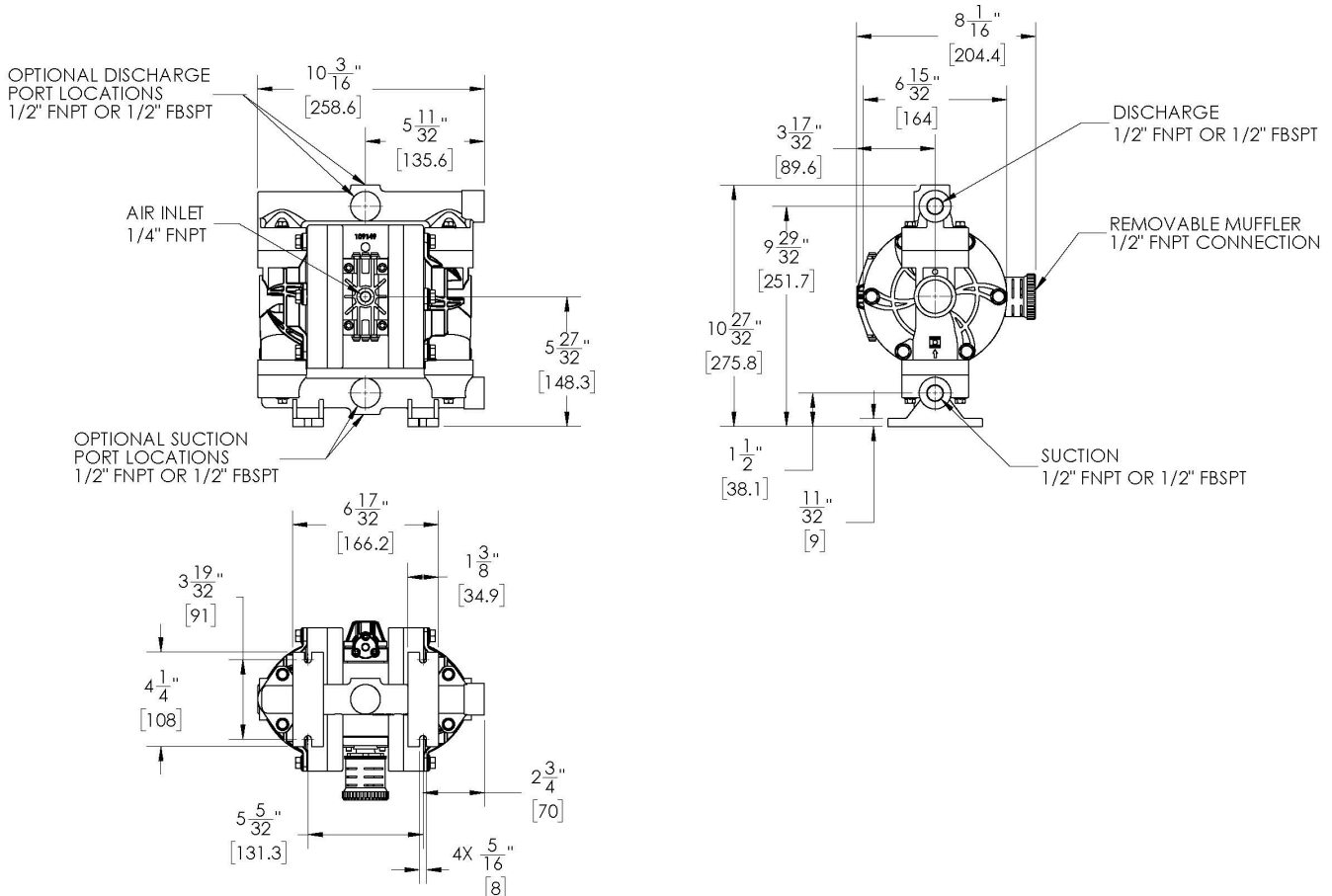

FT05P, FT05C, & FT05V Performance

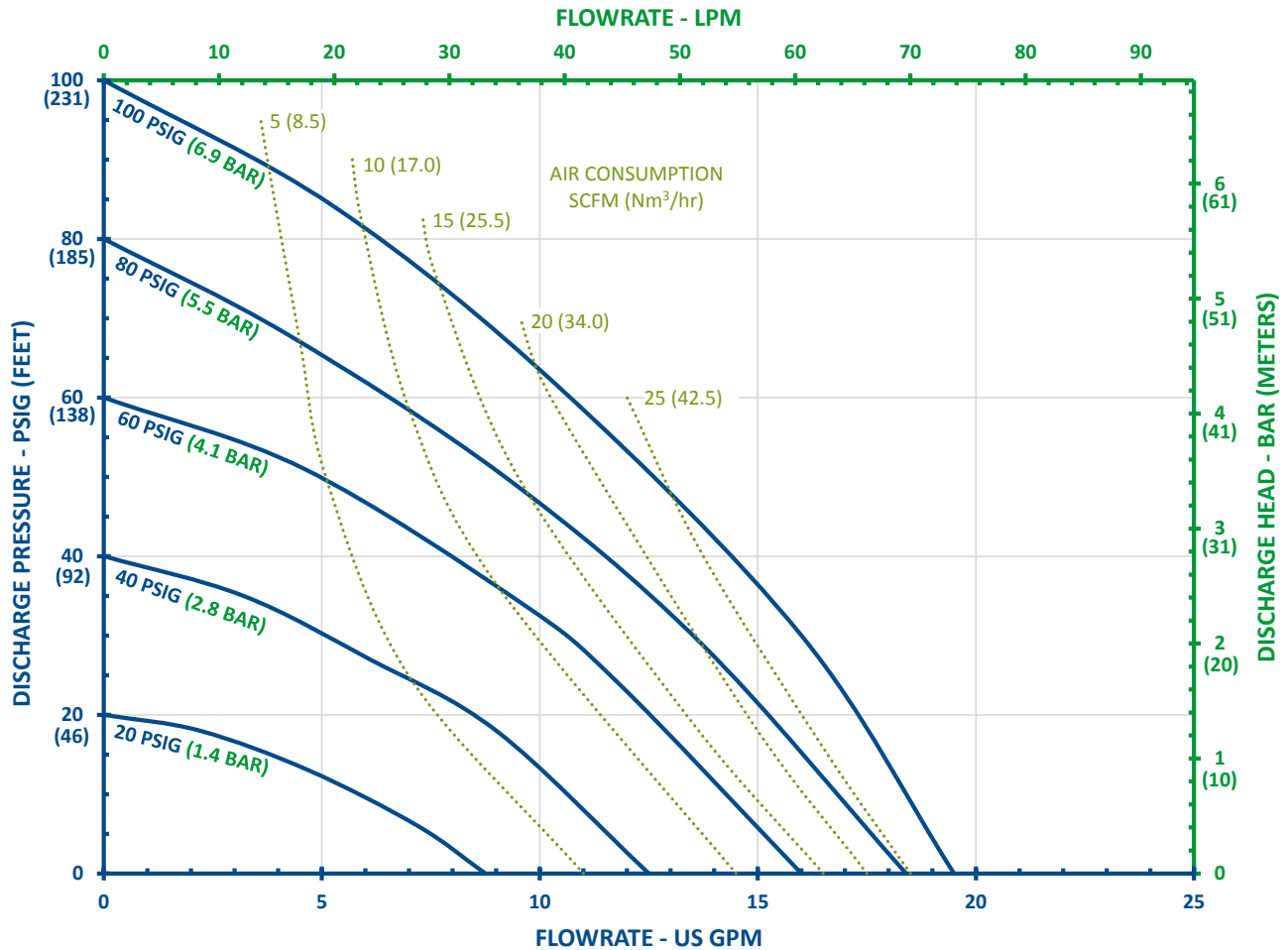

Specifications

Pump Type: Non-Metallic Air Operated Double Diaphragm	
Weight: PP & CFPP - 8.3 lbs (3.8 kgs) PVDF - 11.9 lbs (5.4 kgs)	Max Suction Lift: Wet - 29 ft H ₂ O (8.8 m H ₂ O) Dry - Rubber: 15 ft H ₂ O (4.6 m H ₂ O) PTFE: 12 ft H ₂ O (3.7 m H ₂ O)
Air Inlet/Exhaust Size: 1/4" FNPT x 1/2" FNPT	Max Flow Rate: 19 gpm (72 lpm)
Max Air Inlet Pressure: 100 psig (6.9 bar)	Suction/Discharge Size: 1/2" FNPT/FBSPT
Max Material Inlet Pressure: 10 psig (0.7 bar)	Max Particle Size: 0.19" (4.7 mm)
Air Consumption @ 100 psi: 30 scfm (51 Nm ³ /hr)	Max Outlet Pressure: 100 psig (6.9 bar)
Noise Level: 72.1 dB(A)	Displacement Per Stroke: 0.026 gal (0.10 liter)

Installation Drawing

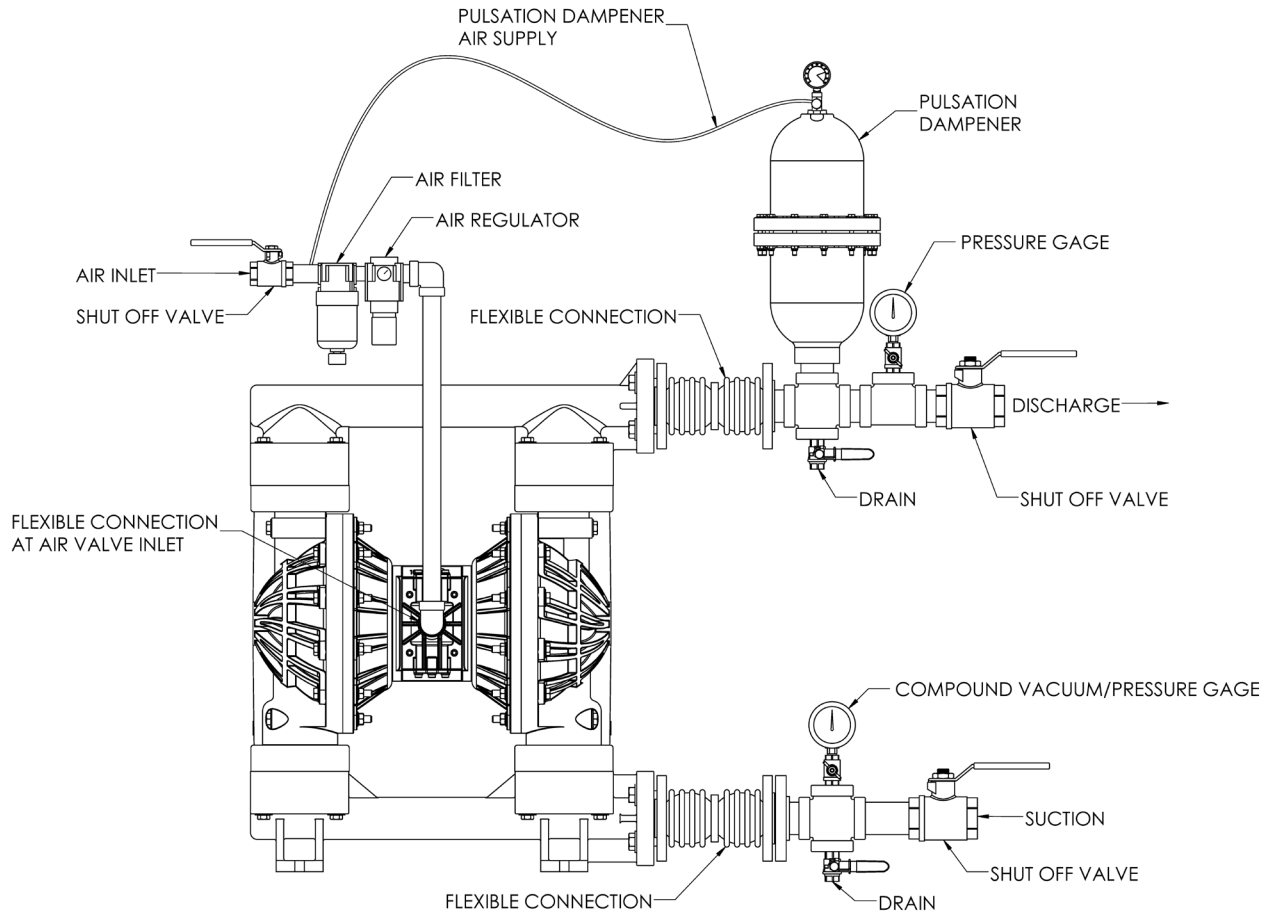

PUMP MUFFLER IS ON THE BACK SIDE OF THE PUMP.
IT CAN BE REMOVED AND EXHAUST CAN BE PIPED TO DESIRED LOCATION.

Installation / Operation Precautions

Installation and Start up

Install the pump in a vertical position or it may not prime properly. Pump should be located as close to the product being pumped as possible. Suction line length should be as short as possible and limit the number of fittings. Suction line diameter should not be reduced smaller than the suction diameter of the pump. When using rigid pipe run short sections of flexible hose or flexible connections between the pump & piping. Secure the pump to a suitable surface.

Air Supply

Connect the pump air inlet to an air supply with sufficient capacity to achieve desired performance. A pressure regulating valve should be installed to insure air supply pressure does not exceed recommended limits.

Air Valve Lubrication

No lubrication is required for the air distribution system.

Fasteners

Re-torque all fasteners before operation. Creep of housing and gasket materials may cause fasteners to loosen. Re-torque all fasteners to the torque specifications listed on the exploded view drawing in this manual.

Air Inlet & Priming

Pump will start to operate as soon as the shut-off valve is opened. It is recommended to open the shut-off valve slowly at first. Once the pump primes; the shut-off valve can be opened additionally to increase the pump's flow. If the pump is operating but not pumping any liquid see the troubleshooting section for tips & suggestions.

Accessories

Surge suppressors, spill stops & filter/regulators are available and should be used with FTI Air pumps.

Troubleshooting Tips & Suggestions

PUMP WILL NOT START OR CYCLE:

- Blocked liquid pipe or hose - Clean out or replace
- Clogged liquid chamber - Remove debris
- Diaphragm shaft bushing / o-ring leak - Replace o-rings
- Air valve carrier not shifting - Inspect, clean, re-oil with 10 wt. air tool oil. (aluminum air valve)
- Air valve carrier not shifting - Inspect, replace seals (polypropylene air valve)

ERRATIC CYCLING:

- Diaphragm failure - Replace diaphragm
- Valve ball not seating properly, worn or damaged – Inspect, remove debris or replace
- Leak in suction line - Inspect, repair or replace
- Diaphragm shaft bushing / o-ring leak - Replace o-rings
- Air valve carrier not shifting - Inspect, clean, re-oil with 10 wt. air tool oil. (aluminum air valve)
- Air valve carrier not shifting - Inspect, replace seals (polypropylene air valve)
- Over lubrication in air valve - Inspect, degrease, reuse. Adjust lubrication
- Excess moisture in air valve – Inspect, dry, reuse. Consider installing an air dryer
- For aluminum air valves, worn carrier or valve bore – measure carrier and valve bore, diametrical clearance should be between .0020” - .0035”. Replace worn components as needed
- For plastic air valves, worn carrier seals – replace carrier seals if there is no longer interference between seals and valve bore

PUMP CYCLES BUT WILL NOT PUMP:

- Too much suction lift - Reduce suction lift or try filling up liquid chambers with fluid
- Leak in suction line - Inspect, repair or replace
- Valve ball not seating properly, worn or damaged - Inspect, remove debris or replace
- Clogged suction pipe or hose - Inspect & clear
- Clogged strainer if used - Inspect & clear
- Diaphragm failure - Replace diaphragm

PUMPED LIQUID RELEASED FROM AIR EXHAUST

- Diaphragm failure - Replace diaphragm
- Outer plate unthreading - Tighten & re-torque

Maintenance

Recommended Tools for Servicing Pump

- 10 & 13 mm box wrenches, (2) 20mm socket wrenches, snap ring pliers; 3 & 5 mm hex wrenches, o-ring pick, & torque wrench.

Wet End Servicing (Installing Wet End Kit)

- Relieve airline pressure and fluid line pressures before conducting maintenance.
- The pump can be drained by turning it upside down and allowing fluid to drain into an appropriate container. Use proper safety equipment when conducting maintenance as internal components may still contain the pumped media.
- Lubricate all stainless steel to stainless steel fasteners to prevent galling. Torque values listed in the back of this manual are for lubricated fasteners.

Wet End Disassembly

1 Remove the (4) discharge manifold bolts (item 11) from the discharge manifold (item 32) using a 10mm wrench.

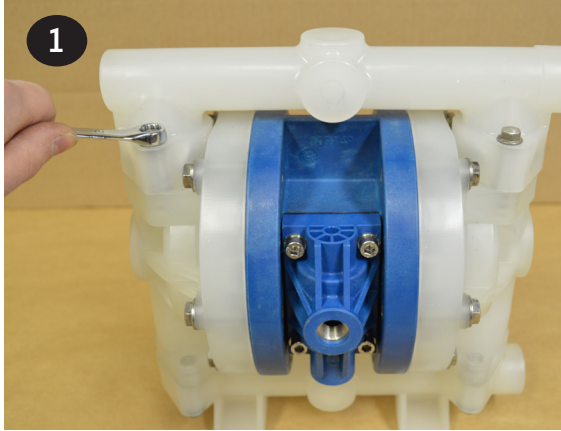

2 The discharge seat o-rings, valve seats and valve balls (items 13, 14, 15 & 16) can now be accessed and replaced if needed.

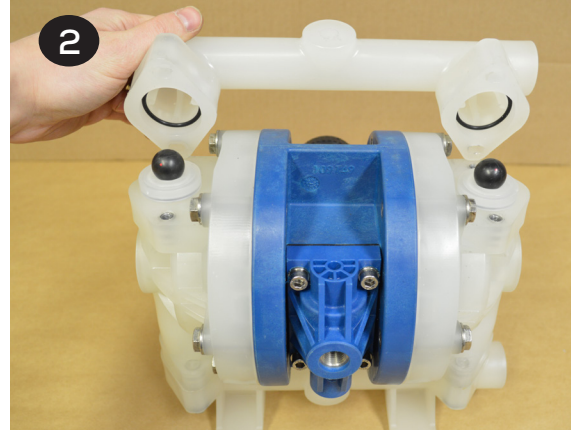

3 Repeat the above steps for the suction manifold (item 12). The seat o-rings, valve seats and valve balls (items 13, 14, 15 & 16) are located in the liquid chambers (item 18).

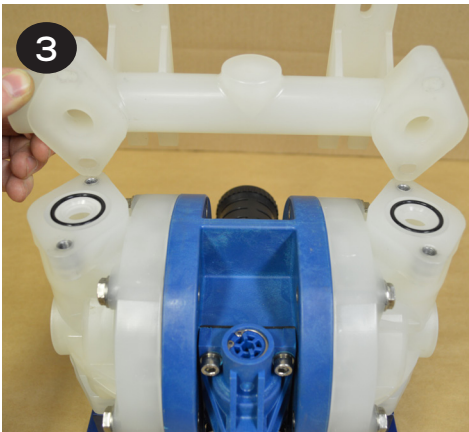

4 Remove both liquid chambers by removing the (6) bolts (items 17) on each liquid chamber using a 13mm (or 1/2") wrench. Inspect and replace diaphragms if needed.



5 To remove the diaphragms (items 20/ 21), begin by loosening the (2) outer plates (item 19) using 2-20mm wrenches. Use 6-sided sockets or wrenches to prevent damage to the hex portion of the outer plate.



6 Remove the outer plate, diaphragm(s), and inner plate (items 19, 20/21 & 22) from the side that is loosened. Pull or push the shaft (item 27) and remaining plates and diaphragms out of the center section. If pulling, it may be easier to grip the diaphragm if it is inverted.

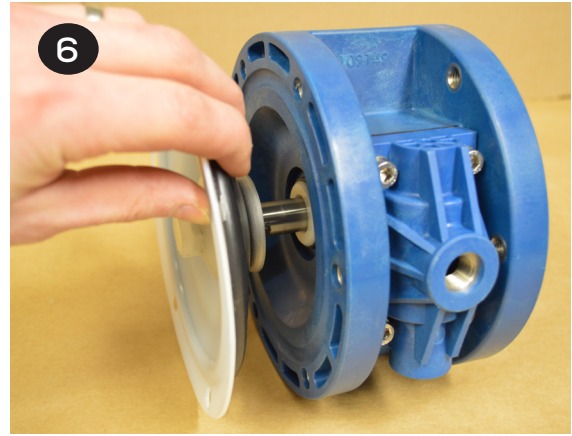
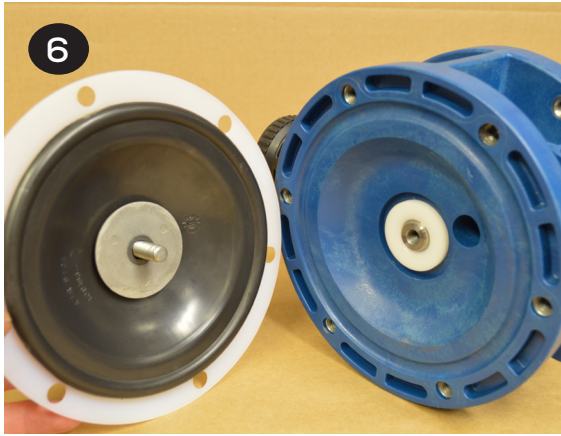

7 To remove the remaining diaphragm(s) (items 20/21) and plates (items 19 & 22) from the shaft (item 27), place the shaft in a vise fitted with soft jaws. Using a 6-sided 20mm wrench, remove the remaining diaphragm(s) and plates. Soft jaws are required to prevent damaging the shaft. A damaged shaft will result in accelerated o-ring wear. Jaws can be fitted with wood, plastic, rubber, or other soft material to prevent shaft damage.



After performing required maintenance, the pump can be reassembled. The pump can also be reassembled using the disassembly instructions in the reverse order as listed above. For detailed assembly instructions, follow steps Wet End Reassembly instructions on next page.

Wet End Reassembly

1 Slide the center hole of one diaphragm (item 21) over the molded in bolt of an outer plate (item 19). The air side of the diaphragm is labeled and should face away from the plastic portion of the outer plate. If the pump is fitted with PTFE diaphragms (item 20), first place a PTFE diaphragm over the molded in bolt of the outer plate (item 19). Then place the backup diaphragm (item 21) on the outer plate. The shape of the PTFE diaphragm and back up diaphragm should roughly conform to one another. See the exploded view drawing for proper orientation.



2 Place the inner plate (item 22) over the molded in bolt. Ensure the round recess in the plate faces the diaphragm (item 21).

Diaphragms are shown inverted to ease assembly.

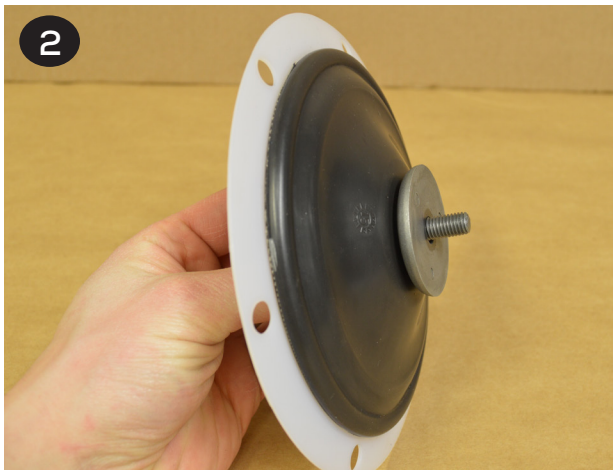

3 Apply a couple drops of a medium strength thread locker, such as Loctite® 246, to the molded in outer plate bolt (item 19). Thread the shaft (item 27) onto the molded in bolt until it is snug to the flat back side of the inner plate (item 22).



4 The shaft (item 27) and shaft o-rings (item 26) should retain the lubricant that was factory applied. If they appear dry, apply a light coat of lithium thickened grease. Avoid over lubrication as it can cause decreased performance of the air distribution system.



5 Push the shaft (item 27) through the center of the shaft bushing (item 24). It is normal for this to be a tight fit, especially if the shaft and shaft o-rings (item 26) are in good condition.

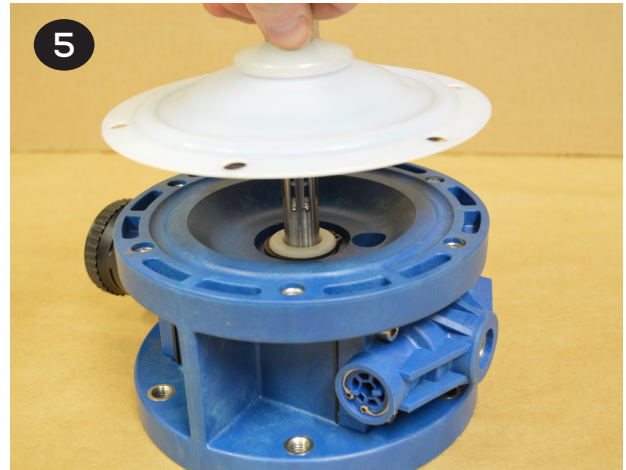

6 The other diaphragm(s) (items 20/21) and inner/outer plates (items 19 & 22) can be installed onto the opposite end of the shaft (item 27). It may be easier to thread the molded in bolt into the shaft if the diaphragm(s) is inverted on one or both sides. This can be done by hand.

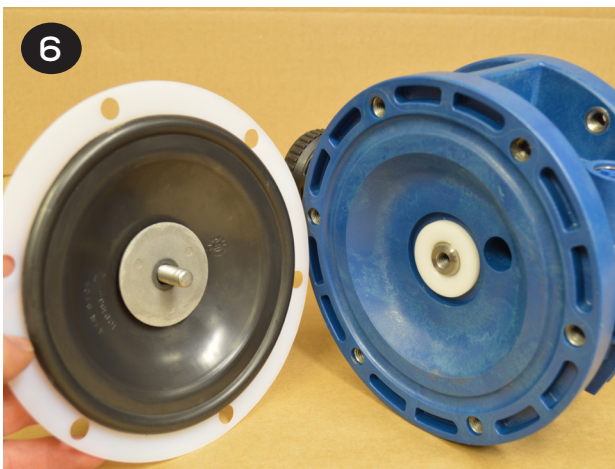

7 Tighten and torque the outer plates (item 19). If the pump is fitted with PTFE diaphragms (item 20), it is necessary to restrict their ability to rotate when tightening the outer plates. This can be done by threading the liquid chamber bolts (item 17) through the PTFE diaphragm holes and into the center section (item 28) on each side. This will ensure that the PTFE diaphragm does not obstruct the bolts ability to thread into the center section when the liquid chambers are installed. Remove these bolts once the outer plates are torqued.

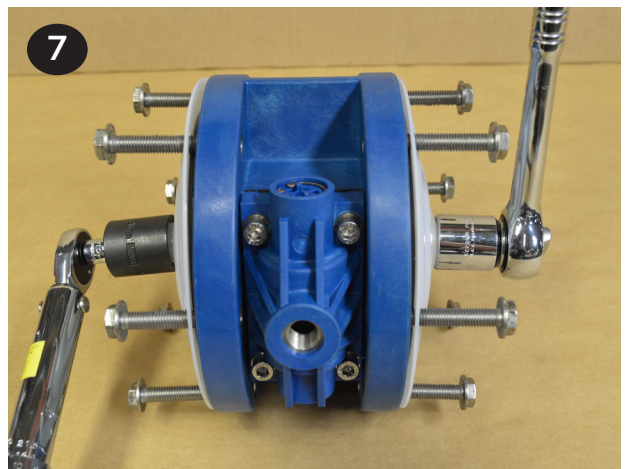

Note: When installing polytetrafluoroethylene (PTFE) diaphragms, it is important to tighten outer plates simultaneously (turning in opposite directions) to ensure tight fit.

8 Install the liquid chambers (item 18) by placing one side over the diaphragm. Start all bolts (item 17) before tightening and torqueing. Torque all fasteners in a star pattern. Repeat to install the second liquid chamber. Ensure both chambers are orientated the same and that the inlet and outlet ports are vertical when facing the front of the pump as shown.

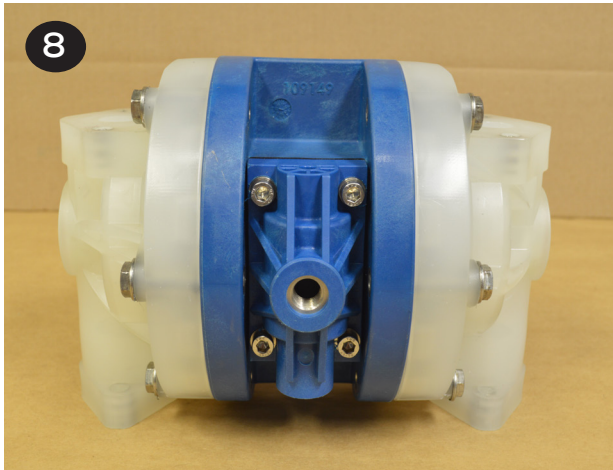

9 Flip the pump upside down and drop the suction valve balls (item 16) into the liquid chamber (item 18) ball cages.

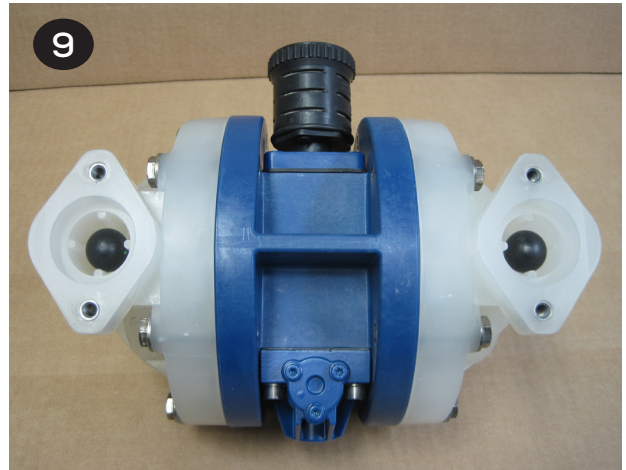

10 Place the larger valve seat o-rings (item 15) into the seat bores of the liquid chambers followed by the valve seats (item 14). Install the two smaller o-rings (item 13) into the face grooves in the valve seats. The seats are to be orientated so that the edge groove on the seat accepts the larger o-ring.

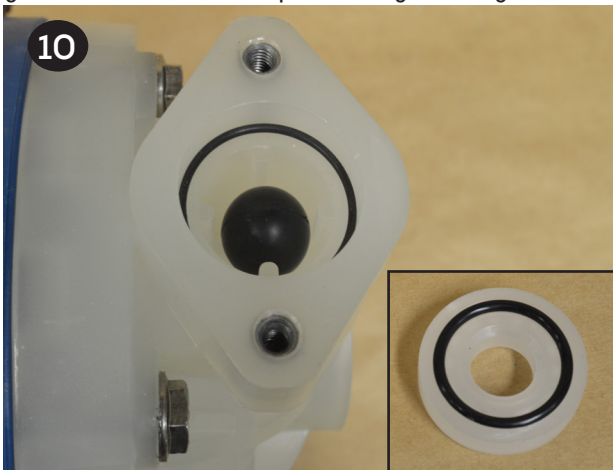

11 Check that the top of the seat (item 14) is about flush with the liquid chamber. Place the suction manifold (item 12) atop the pump. Tighten and torque the suction manifold bolts (item 11) in an “X” pattern.

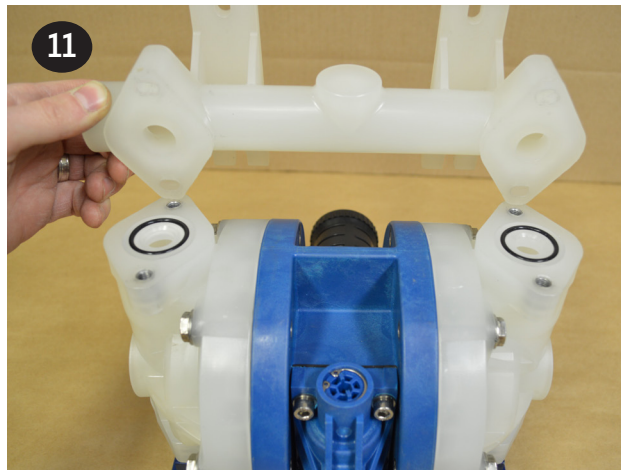

12 Stand the pump upright onto the suction manifold feet (item 12). Place the small valve seat o-rings (item 13) on the flat faces of the liquid chambers (item 18) followed by the valve seats (item 14) on the o-rings. Place the valve balls (item 16) onto the valve seats. The larger valve seat o-rings (item 15) can be installed into the discharge manifold (item 32). Place the manifold atop the pump, over the components that are on top of the liquid chambers. Tighten and torque the discharge manifold bolts in an “X” pattern.

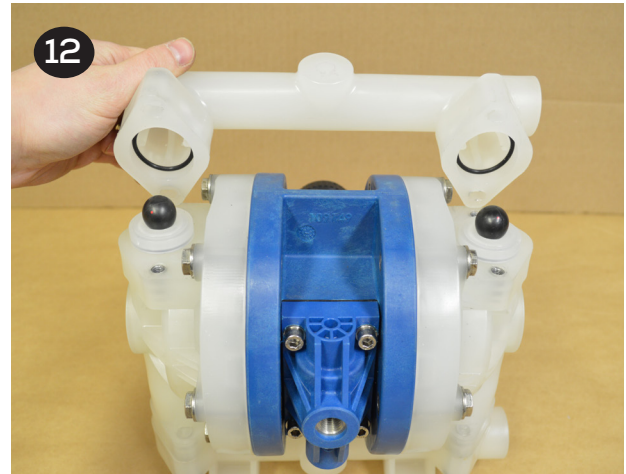

Air End Servicing (Installing Air End Kit)

- Follow steps 1 – 6 in the Wet End Servicing disassembly section to access the shaft bushing (item 24) and o-rings (items 23 & 26), then follow steps below.

Shaft, Bushing, & O-ring Replacement

1 Remove the shaft bushing retaining ring (item 25) and push the shaft bushing out of the center section.

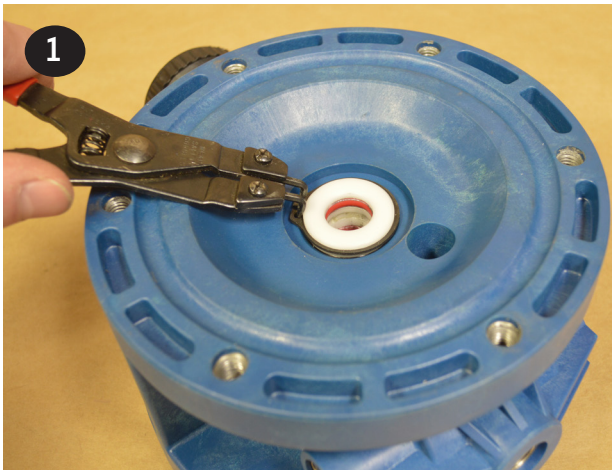

2 Use the supplied grease packets to lightly grease the OD and ID o-rings (items 23 & 26) that come preinstalled in the new shaft bushing supplied in air end kits.

Insert the shaft bushing into the center section (item 28) and reinstall the retaining ring.

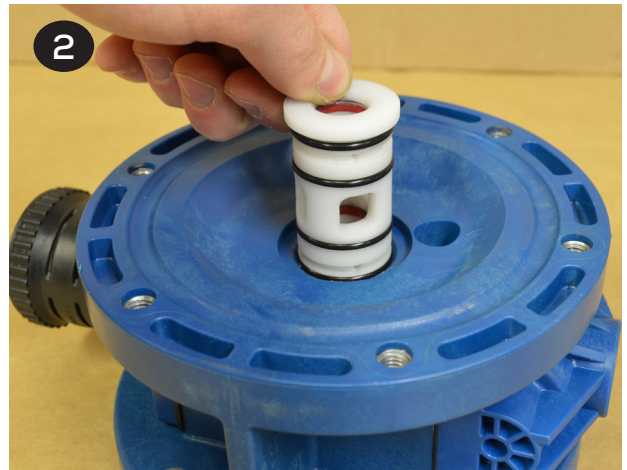

3 Inspect the shaft (item 27) for damage. It is common for shafts to become grooved during service. Grooving is normally caused by carbonized oil and/or abrasive foreign material getting trapped between the seal and the shaft. Over time, deep grooves can form in the shaft. When that occurs, it is recommended that the shaft be replaced.

- After determining if the condition of the shaft is acceptable, follow steps 5 – 12 in the Wet End Servicing – Wet End Reassembly section to rebuild the rest of the pump.



Air Valve O-Ring Replacement

1 **Plastic Air Valve** - To replace the valve cap o-ring remove the retaining ring (item 8), then pull straight up. The use of an M6 bolt, vise grip, and pry bars may be necessary. See 1 and 1A pictures below.

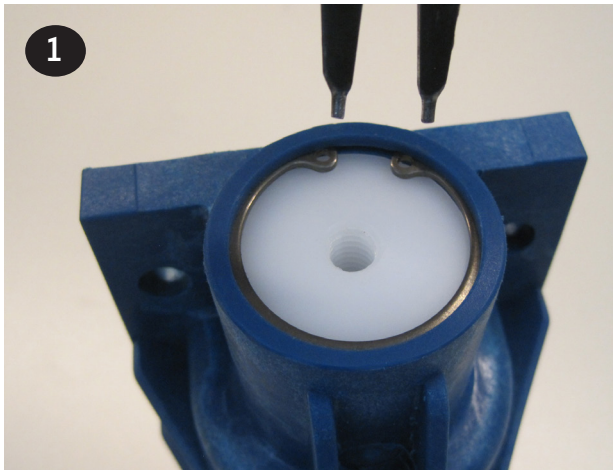

1 **Aluminum Air Valve** - To replace the valve cap o-rings (item 5), remove the (3) button head cap screws (item 7) using a 3mm hex wrench.



2 Plastic Air Valve - Remove and replace o-ring (item 5). Insert cap (item 6) and push down until groove for the retaining ring is visible. Make sure to lubricate the o-rings prior to inserting into the valve body with a compatible lubricant.

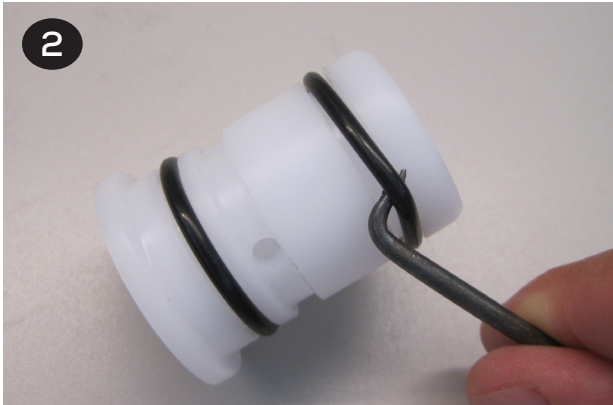

2 Aluminum Air Valve - Remove and replace o-ring (item 5). Install cap (item 6), tighten, and torque the valve cap screws (item 7). Repeat for the remaining cap.

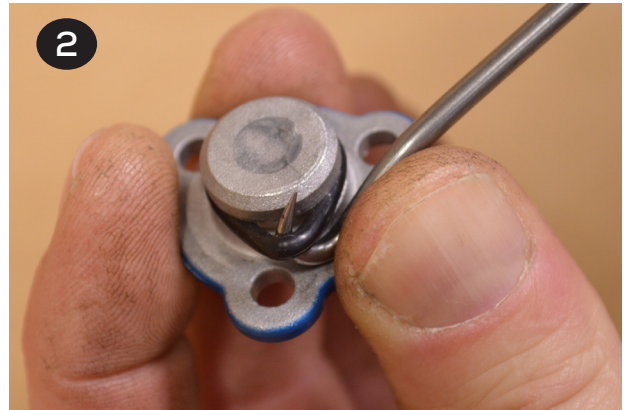

Valve and Muffler Gasket Replacement

1 Remove the valve body (item 3) by removing the four (4) socket head cap screws (item 1) that attach the valve body to the muffler plate (item 31) with a 5mm hex wrench



2 Pull the valve body and gasket (items 3 & 30) off the front of the center section (item 28) and the muffler plate gasket, muffler plate and muffler (items 29, 31 & 33) off the back.



3 Place the new gasket (item 30) on the air valve (item 3) and ensure the slots in the gasket align with the slots in the air valve and valve plate (item 10).

Air Valve Slide, Plate & Gasket Orientation: If the valve plate (item 10) and slide valve (item 9) are removed, ensure they are installed in the proper orientation. The flat face of the slide valve sits in the pocket of the valve carrier (item 4) so that the square cut out on the slide valve faces the smooth polished side of the valve plate

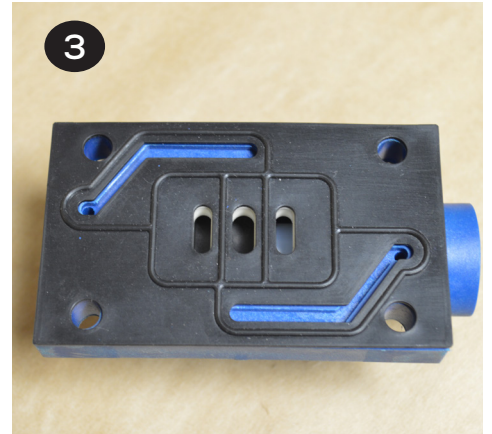
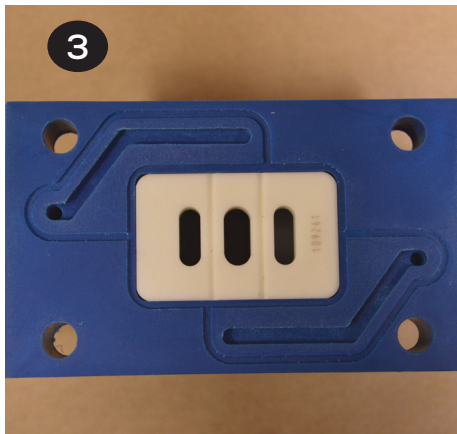
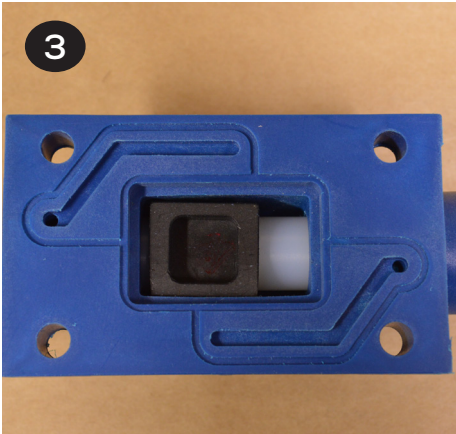

4 Insert the (4) cap screws & washers (items 1 & 2) through the valve body and gasket (items 3 & 30) and place onto the center section (item 28). Ensure the slide valve and valve plate (items 9 & 10) are in place and the valve sits flat on the center section.

5 Place the muffler gasket (item 29) over the four (4) cap screws (item 1) on the back side of the center section (item 28) followed by the muffler plate and muffler (items 31 & 33).

6 Tighten and torque the (4) cap screws into the muffler plate.

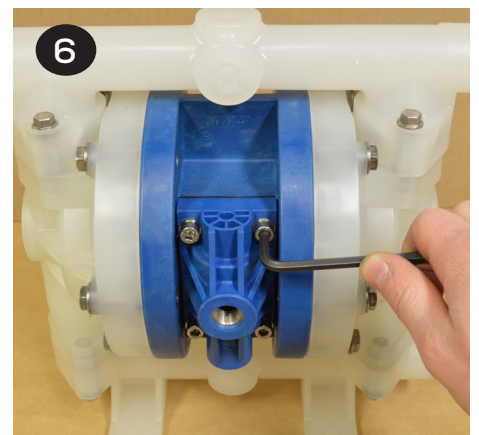
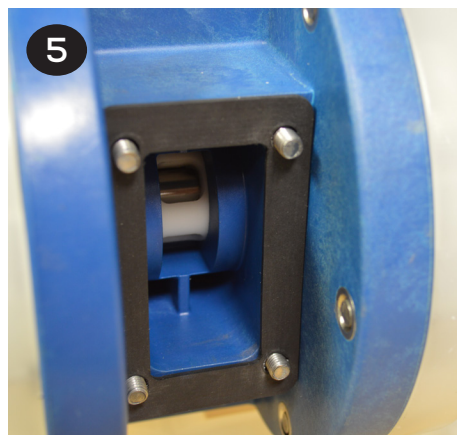
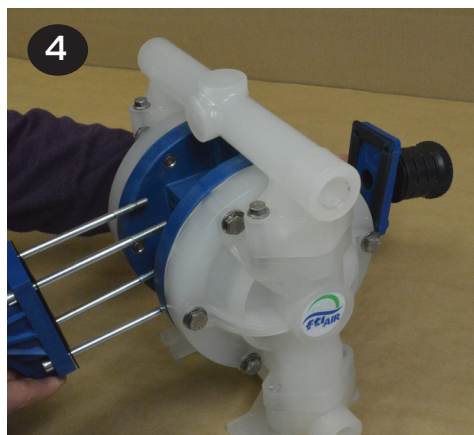

Replacement Air Valve Kit Installation

1. Remove the valve that is to be replaced by removing the (4) socket head cap screws with a 5mm hex wrench that attaches the valve body to the muffler plate.
 2. Save the (4) cap screws, (4) lock washers, muffler plate, and muffler. All other valve components can be discarded.
 3. Remove the packing tape that holds the air valve components in place during shipping.
- Follow steps 3 – 6 in the Valve and Muffler Gaskets section of Air End Servicing above.

Exploded View & Spare Parts List

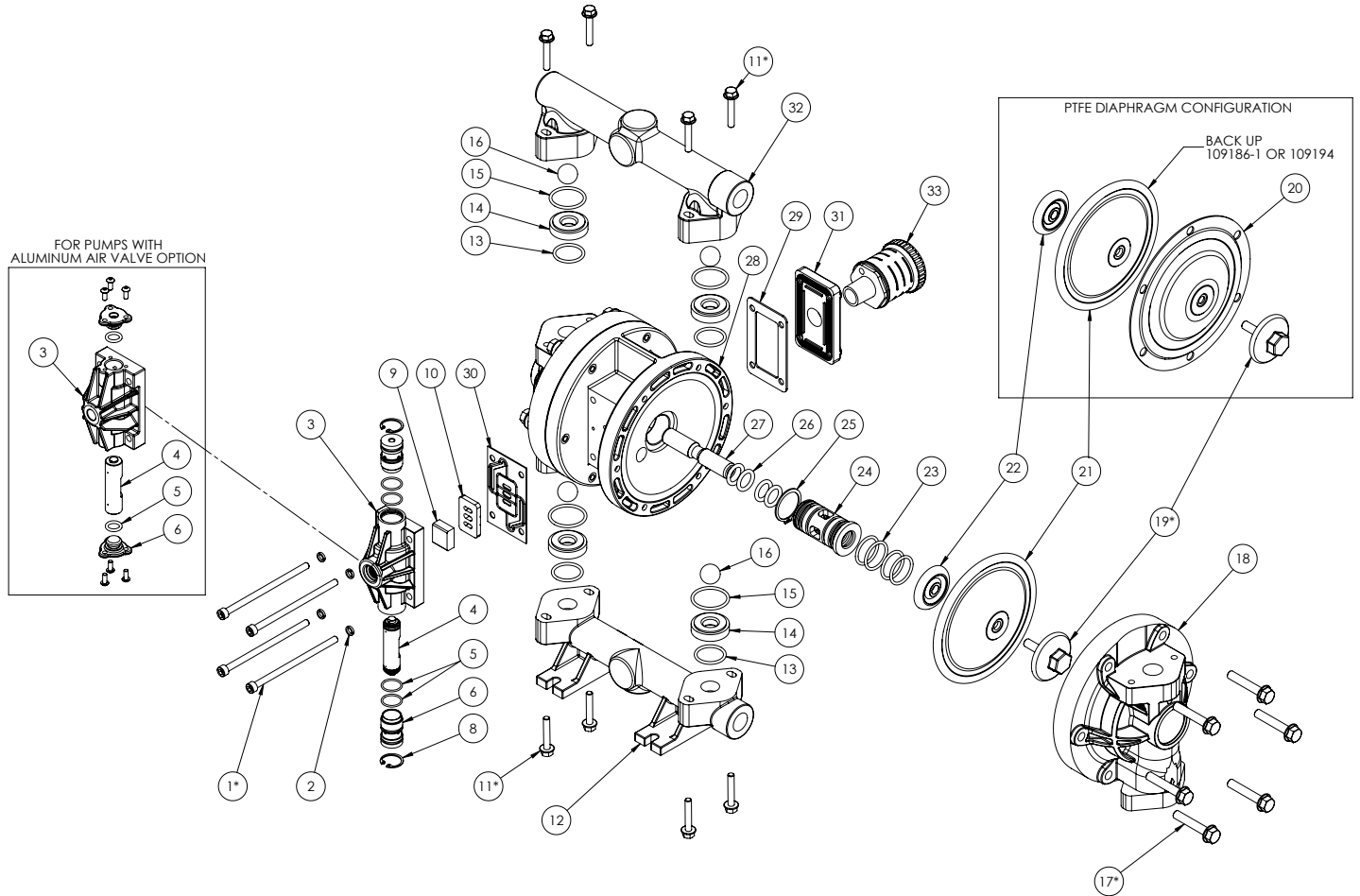

ITEM	DESCRIPTION	PART NO.	QTY	KIT
1	CAP SCREW, SOCKET HD M6X1.0 X 110MM SSTL	109519	4	-
2	WASHER, LOCK M6 HIGH-COLLAR SSTL	109517	4	-
3	VALVE BODY	SEE AIR VALVE TABLES		V1/V2
4	VALVE CARRIER	SEE AIR VALVE TABLES		V1/V2
5	VALVE CAP O-RING	SEE AIR VALVE TABLES		A1/A2/V1/V2
6	VALVE CAP	SEE AIR VALVE TABLES		V1/V2
7	CAP SCREW, SOCKET HD M4X0.7 X 10MM	SEE AIR VALVE TABLES		V2
8	RETAINING RING, HO-81 SSTL	SEE AIR VALVE TABLES		V1
9	SLIDE VALVE	109257	1	V1/V2
10	VALVE PLATE	109261	1	V1/V2
11	CAP SCREW, HEX HD FLNG M6X1.0 X 35MM SSTL	109505	8	-
12	MANIFOLD, SUCTION, POLYPROPYLENE, FDA & CONDUCTIVE POLYPRO	SEE MANIFOLD TABLES		-
	MANIFOLD, SUCTION, PVDF			

ITEM	DESCRIPTION	PART NO.	QTY	KIT
13	O-RING, VALVE SEAT LOWER, BUNA-N	109418	4	W
	O-RING, VALVE SEAT LOWER, FKM	109446		
	O-RING, VALVE SEAT LOWER, POLYURETHANE	109447		
	O-RING, VALVE SEAT LOWER, SANTOPRENE	109448		
	O-RING, VALVE SEAT LOWER, FEP ENCAPSULATED FKM, FDA	109326		
14	VALVE SEAT, POLYPROPYLENE, FDA	109291	4	W
	VALVE SEAT, PVDF	109296		
15	O-RING, VALVE SEAT UPPER, BUNA-N	109580	4	W
	O-RING, VALVE SEAT UPPER, FKM	109583		
	O-RING, VALVE SEAT UPPER, POLYURETHANE	109585		
	O-RING, VALVE SEAT UPPER, SANTOPRENE	109587		
	O-RING, VALVE SEAT UPPER, FEP ENCAPSULATED FKM, FDA	109586		
16	VALVE BALL, NEOPRENE (GREEN DOT)	109203	4	W
	VALVE BALL, BUNA-N (RED DOT)	109207		
	VALVE BALL, EPDM (BLUE DOT)	109211		
	VALVE BALL, FKM (WHITE OR SILVER DOT)	109215		
	VALVE BALL, SANTOPRENE (RED BALL)	109219		
	VALVE BALL, SANTOPRENE, FDA (NATURAL)	109219-1		
	VALVE BALL, PTFE, FDA (WHITE BALL)	109199		
	VALVE BALL, 316 STAINLESS STEEL, FDA	109368		
	VALVE BALL, WEIGHTED PTFE, FDA (WHITE BALL)	109377		
17	CAP SCREW, HEX HD FLNG M8X1.25 X 45MM	109508	12	-
18	LIQUID CHAMBER, POLYPROPYLENE, FDA	109767-3	2	-
	LIQUID CHAMBER, CONDUCTIVE POLYPROPYLENE	109767-17		
	LIQUID CHAMBER, PVDF	109767-4		
19	OUTER PLATE, POLYPROPYLENE	109153	2	-
	OUTER PLATE, CONDUCTIVE POLYPROPYLENE	109153-1		
	OUTER PLATE, PVDF	109156		
20	DIAPHRAGM, PTFE (WHITE), FDA - REQUIRES BACK UP	109182	2	W
21	DIAPHRAGM, NEOPRENE (GREEN DOT)	109186-1	2	W
	DIAPHRAGM, BUNA-N, FDA (RED DOT)	109186-2		
	DIAPHRAGM, EPDM (BLUE DOT)	109186-3		
	DIAPHRAGM, FKM (WHITE OR SILVER DOT)	109186-4		
	DIAPHRAGM, SANTOPRENE (RED)	109194		
	DIAPHRAGM, SANTOPRENE, FDA (NATURAL)	109194-1		
	DIAPHRAGM, HYTREL (CREAM)	109190		
	DIAPHRAGM, HYTREL, FDA (NATURAL)	109190-1		
	DIAPHRAGM, POLYURETHANE (BEIGE)	109435		
22	INNER PLATE, ALUMINUM	109168	2	-
	INNER PLATE, STAINLESS STEEL	109717	2	-
23	O-RING, BUSHING OD	109418	4	A1/A2
24	SHAFT BUSHING W/ O-RINGS (ITEMS 23 & 26)	109669	1	A1/A2
25	RETAINING RING	109467	1	A1/A2
26	O-RING, SHAFT	109422	4	A1/A2
27	SHAFT	109173	1	-

ITEM	DESCRIPTION	PART NO.	QTY	KIT
28	CENTER SECTION, GLASS-FILLED POLYPROPYLENE	109149	1	-
	CENTER SECTION, CONDUCTIVE POLYPROPYLENE	109149-1		
29	GASKET, MUFFLER	109426	1	A1/A2/V1/V2
30	GASKET, AIR VALVE	109265	1	A1/A2/V1/V2
31	MUFFLER PLATE	109269	1	-
	MUFFLER PLATE, CONDUCTIVE POLYPROPYLENE, ATEX	109269-1		
32	MANIFOLD, DISCHARGE, POLYPROPYLENE & CF POLYPROPYLENE	SEE MANIFOLD TABLES		-
	MANIFOLD, DISCHARGE, PVDF			
33	MUFFLER	109561	1	-
	MUFFLER PLATE, CONDUCTIVE POLYPROPYLENE, ATEX	109561-1		
35	PIPE PLUG	SEE MANIFOLD TABLES		-
36	GROUNDING LUG	108091	1	-

KIT COLUMN KEY:

W - PARTS SUPPLIED IN A WET SIDE KITS

A1 - PARTS SUPPLIED IN PLASTIC VALVE AIR END KIT 109905

A2 - PARTS SUPPLIED IN ALUMINUM VALVE AIR END KIT 109594

V1 - PARTS SUPPLIED IN PLASTIC REPLACEMENT VALVE KIT 111244

V2 - PARTS SUPPLIED IN ALUMINUM REPLACEMENT VALVE KIT 109588

V3 - PARTS SUPPLIED IN CONDUCTIVE ACETAL REPLACEMENT VALVE KIT 111244-1

PUMPS FITTED WITH GFRPP AIR VALVES FT05_-P-____-__				
ITEM	DESCRIPTION	PART NO.	QTY	KIT
3	VALVE BODY, GFRPP	109902	1	V1
4	VALVE CARRIER WITH SEALS	111363	1	V1
5	VALVE CAP O-RING	109877	4	A1/V1
6	VALVE CAP, DELRIN	109876	2	V1
8	RETAINING RING, HO-81SSTL	109649	2	V1

PUMPS FITTED WITH CONDUCTIVE ACETAL AIR VALVES FT05_-D-____-__				
ITEM	DESCRIPTION	PART NO.	QTY	KIT
3	VALVE BODY, CONDUCTIVE ACETAL	109902-1	1	V3
4	VALVE CARRIER WITH SEALS	111363	1	V3
5	VALVE CAP O-RING	109877	4	A1/V3
6	VALVE CAP, DELRIN	109876	2	V3
8	RETAINING RING, HO-81SSTL	109649	2	V3

PUMPS FITTED WITH ALUMINUM AIR VALVES FT05_-A-____-__				
ITEM	DESCRIPTION	PART NO.	QTY	KIT
3	VALVE BODY, ALUMINUM	SEE ITEM 34	1	V2
4	VALVE CARRIER, ALUMINUM	109450	1	V2
5	VALVE CAP O-RING	J101380	2	A2/V2
6	VALVE CAP, ALUMINUM	SEE ITEM 34	2	V2
7	CAP SCREW, SOC. HD M4X0.7X10	109511	6	V2
34	CONTAINS ITEMS 3, 4, 5, 6, & 7	109591	1	V2

SUCTION MANIFOLD (ITEM 12)

BEGINNING OF MODEL NUMBER	LAST 2 DIGITS OF MODEL NUMBER															
	N1		N2*		N3*		N4*		B1		B2*		B3*		B4*	
	PART NO.	QTY	PART NO.	QTY	PART NO.	QTY	PART NO.	QTY	PART NO.	QTY	PART NO.	QTY	PART NO.	QTY	PART NO.	QTY
FT05P - ITEM 12	109117	1	109608	1	109608-1	1	109608-1	1	109117-1	1	109608-2	1	109608-3	1	109608-3	1
ITEM 35 (NOT SHOWN)	N/A	0	109637	1	109637	1	109637	1	N/A	0	109638	1	109638	1	109638	1
FT05V - ITEM 12	109120	1	109608-4	1	109608-5	1	109608-5	1	109120-1	1	109608-6	1	109608-7	1	109608-7	1
ITEM 35 (NOT SHOWN)	N/A	0	109639	1	109639	1	109639	1	N/A	0	109640	1	109640	1	109640	1
FT05C - ITEM 12	109117-2	1	N/A	0	N/A	0	N/A	0	109117-3	1	N/A	0	N/A	0	N/A	0

DISCHARGE MANIFOLD (ITEM 32)

BEGINNING OF MODEL NUMBER	LAST 2 DIGITS OF MODEL NUMBER															
	N1		N2*		N3*		N4		B1		B2*		B3*		B4	
	PART NO.	QTY	PART NO.	QTY	PART NO.	QTY	PART NO.	QTY	PART NO.	QTY	PART NO.	QTY	PART NO.	QTY	PART NO.	QTY
FT05P - ITEM 32	109132	1	109607	1	109607-1	1	109132	1	109132-1	1	109607-2	1	109607-3	1	109132-1	1
ITEM 35 (NOT SHOWN)	N/A	0	109637	1	109637	1	N/A	0	N/A	0	109638	1	109638	1	N/A	0
FT05V - ITEM 32	109135	1	109607-4	1	109607-5	1	109135		109135-1	1	109607-6	1	109607-7	1	109135-1	1
ITEM 35 (NOT SHOWN)	N/A	0	109639	1	109639	1	N/A	0	N/A	0	109640	1	109640	1	N/A	0
FT05C - ITEM 32	109132-2	1	N/A	0	N/A	0	N/A	0	109132-3	1	N/A	0	N/A	0	N/A	0

*NOTE: Open, unused ports must be sealed with pipe plugs (item 35). Order if not reusing existing plugs.

FT05P, FT05C, & FT05V Maximum Torque Settings*	
Item #	Torque
1	7 N-m (60 in-lbs)+
7	4 N-m (35 in-lbs)+
11	8 N-m (72 in-lbs)+
17	12 N-m (108 in-lbs)+
19	22 N-m (196 in-lbs)+
Asterisk (*) from the exploded view diagram indicates fasteners to be torqued. Stainless Steel to Stainless Steel fasteners should be lubricated to prevent galling. A Plus sign (+) on the above torque values indicates a lubricated fastener.	

Warranty



FTI Air A Division of Finish Thompson, Inc (manufacturer) warrants this pump product to be free of defects in materials and workmanship for a period of five years from date of purchase by original purchaser. If a warranted defect, which is determined by manufacturer's inspection, occurs within this period, it will be repaired or replaced at the manufacturer's option, provided (1) the product is submitted with proof of purchase date and (2) transportation charges are prepaid to the manufacturer.

Liability under this warranty is expressly limited to repairing or replacing the product or parts thereof and is in lieu of any other warranties, either expressed or implied. This warranty does not apply to normal wear of the product or components. This warranty does not apply to products or parts broken due to, in whole or in part, accident, overload, abuse, chemical attack, tampering, or alteration. The warranty does not apply to any other equipment used or purchased in combination with this product. The manufacturer accepts no responsibility for product damage or personal injuries sustained when the product is modified in any way. If this warranty does not apply, the purchaser shall bear all cost for labor, material and transportation.

Manufacturer shall not be liable for incidental or consequential damages including, but not limited to process down time, transportation costs, costs associated with replacement or substitution products, labor costs, product installation or removal costs, or loss of profit. In any and all events, manufacturer's liability shall not exceed the purchase price of the product and/or accessories



FINISH THOMPSON INC. - HEADQUARTERS

921 Greengarden Road | Erie, PA 16501
800.934.9384 | ph 814.455.4478 | fx 814.455.8518
email fti@finishthompson.com

FINISH THOMPSON GMBH - EUROPE CENTER

Otto-Hahn-Strasse 16 | Maintal, D-63477 Germany
49 (0)6181-90878-0 | fx 49 (0)6181-90878-18
email fti@finishthompson.com