

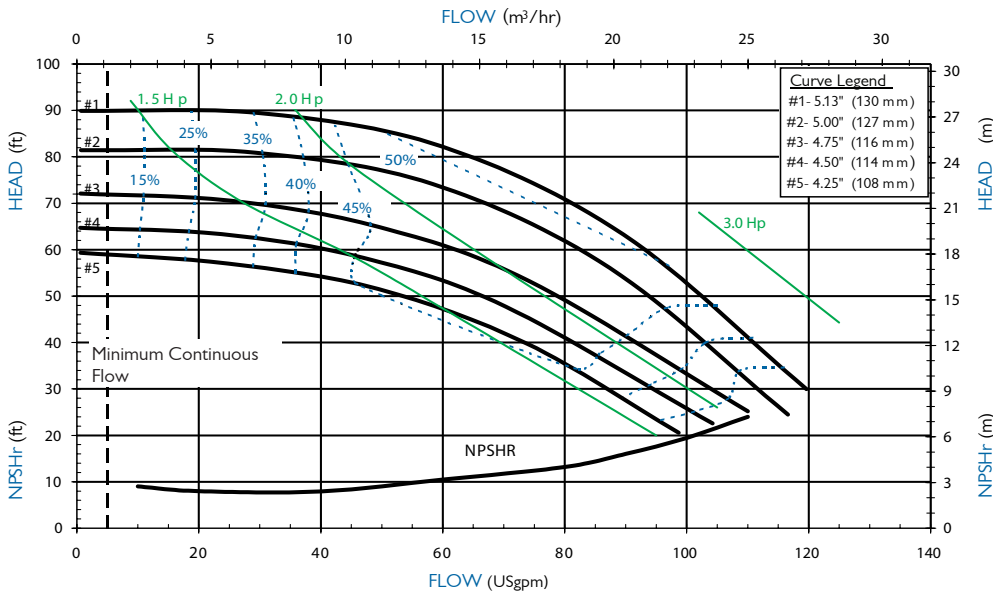

SP SERIES MODEL SP15



SP15 PERFORMANCE Flooded Suction 3450 RPM*



SP15 PERFORMANCE Flooded Suction 2900 RPM*

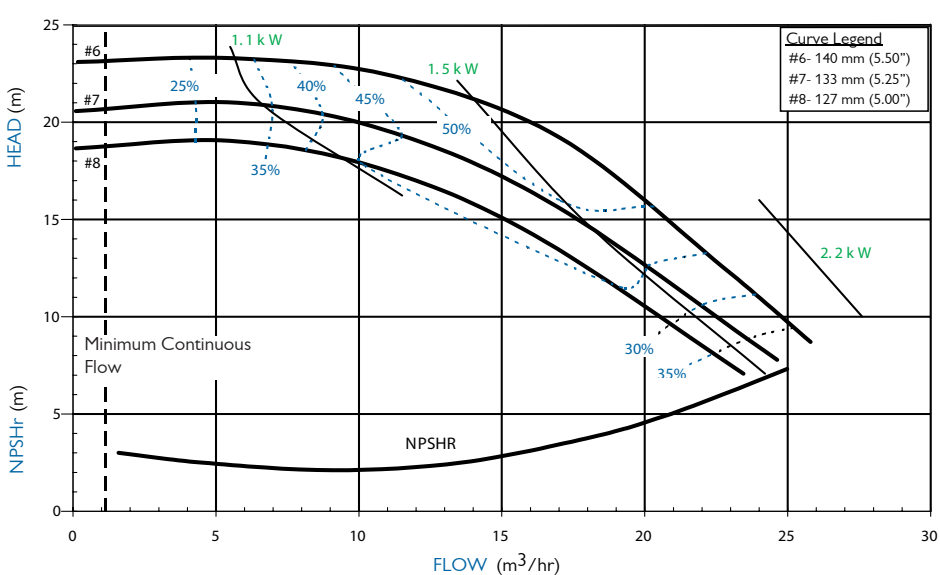

Notes: Performance curves above are based on flooded suction.

*Performance will vary with suction lift conditions. For performance at various suction lifts, see curve book on FTI web site (www.finishthompson.com) or contact factory.

Warning! SP Series not recommended for pumping flammables!

FEATURES & CAPABILITIES

- + Self-priming, magnetic drive
- + Five-year warranty
- + Provides up to 25 ft. (7.6 m) lift or equivalent
- + Primes 18 ft. (5.5 m) in 90 seconds with maximum diameter impeller
- + Retains fluid for re-priming when shut off without a check valve
- + Extended run dry ability (with carbon bushing)
- + High operating efficiency
- + Polypropylene or PVDF construction
- + Powerful neodymium magnets
- + Close-coupled design
- + Threaded (NPT or BSP), union or flange connections
- + Back pullout design
- + Mounts to NEMA and (B5 & B14) IEC motor frames
- + Easy set measurement free drive
- + ISO 1940 G2.5 balancing
- + CE certified
- + High working pressure up to 90 psi (6.2 bar)
- + Specific gravity over 1.8
- + Polypropylene—180° F (82° C)
- + PVDF—220° F (104° C)

APPLICATIONS

- + Rail cars
- + Tanker trucks
- + Tanks with an opening on top
- + Bulk storage to day or process tank transfer
- + Sumps and reservoirs
- + Below grade storage tanks
- + Over-the-wall applications
- + When run-dry protection is needed
- + and many more!

SP SERIES

Specifications

Description	Polypropylene	PVDF
1 Housing	Glass-fiber reinforced polypropylene (GF PP)	Carbon-fiber reinforced PVDF (CF PVDF)
4 Separator plate		
6 Inner volute		
7 Impeller		
3A, 5, 10 O-ring options	FKM, EPDM	
3* Fill and drain plugs	Polypropylene	PVDF
6A Inner volute thrust ring	High purity alumina ceramic, or silicon carbide (SiC)	
7A Impeller thrust ring	GF molybdenum disulfide filled PTFE, or SiC	
8 Inner drive	Neodymium iron boron magnets encapsulated in unfilled polypropylene	Neodymium iron boron magnets encapsulated in unfilled PVDF
8A Bushing	Carbon, PTFE, high purity alumina ceramic, or SiC	
9 Shaft	High purity alumina ceramic, Hastelloy® C, or SiC	
11 Barrier	GF PP	CF PVDF
11A Barrier thrust ring	High purity alumina ceramic	
12 Motor adapter	Ductile iron	
13 Outer drive magnets	Nickel-plated neodymium iron boron magnets/steel	
14* Motor adapter sealing kit (NEMA only)	Buna N	

*Not shown

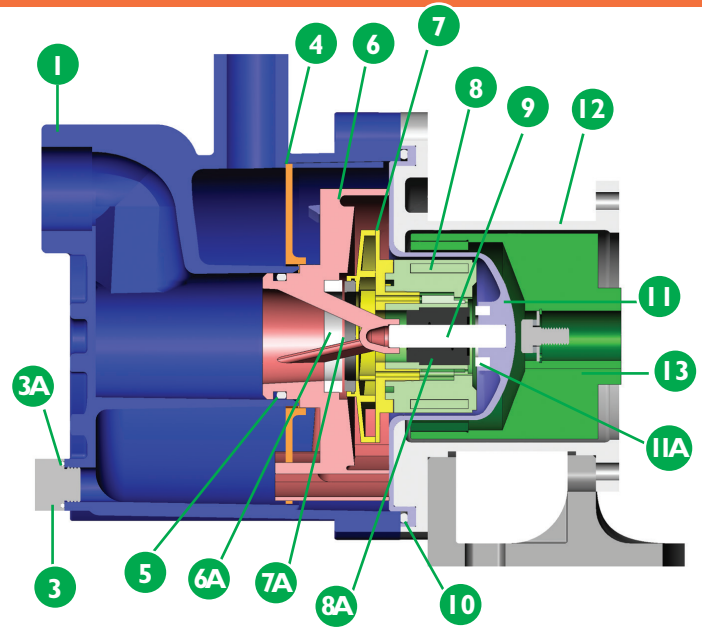

Hastelloy® C is a registered trademark of Haynes International, Inc.

Dimensions

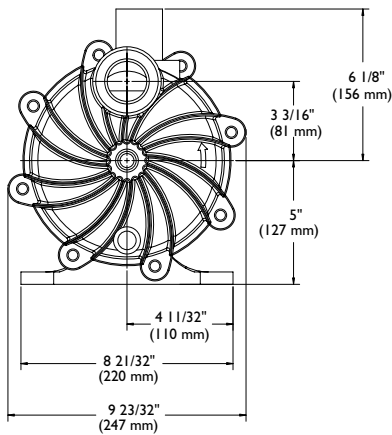

Also available 1-1/2" x 1-1/2" 150 lb. ANSI/ISO PN20/PN40/JIS 10K or 50mm x 50mm union connection. Flanges are in compliance with bolting dimensions only.

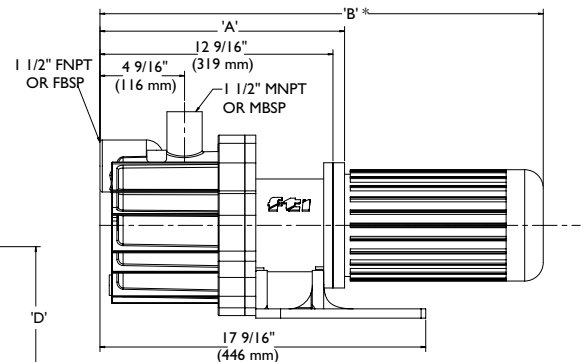
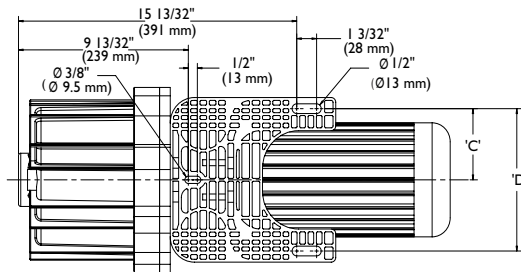

Motor Frame	A	B	C [†]	D [†]	lbs. [kg] PP	lbs. [kg] PVDF
NEMA 56C	12-9/16" [31.9 cm]	24-9/16" [62.4 cm]	3-3/4" [9.5 cm]	7-1/2" [19.1 cm]	25 [11.3]	30 [13.6]
NEMA 145TC	12-9/16" [31.9 cm]	23-5/16" [59.2 cm]	3-3/4" [9.5 cm]	7-1/2" [19.1 cm]	25 [11.3]	30 [13.6]
NEMA 184TC	13-7/16" [31.4 cm]	25-11/16" [66.6 cm]	3-3/4" [9.5 cm]	7-1/2" [19.1 cm]	26 [11.8]	31 [14.1]
IEC 80/90 w/B14 or B5	13-3/16" [33.5 cm]	23-7/8" [60.6 cm]	3-3/4" [9.5 cm]	7-1/2" [19.1 cm]	25.5 [11.6]	30.5 [13.8]
IEC 100 w/B14	13-1/4" [33.7 cm]	25-13/32" [64.5 cm]	3-5/32" [8.0 cm]	6-10/32" [16.0 cm]	25.5 [11.6]	30.5 [13.8]
IEC 112 w/B14	13-1/4" [33.7 cm]	25-29/32" [65.8 cm]	3-3/4" [9.5 cm]	7-1/2" [19.1 cm]	25.5 [11.6]	30.5 [13.8]
IEC 100 w/B5	13-1/4" [33.7 cm]	25-25/32" [65.5 cm]	3-5/32" [8.0 cm]	6-10/32" [16.0 cm]	31.5 [14.3]	36.5 [16.6]
IEC112 w/B5	13-1/4" [33.7 cm]	26-5/8" [67.6 cm]	3-3/4" [9.5 cm]	6-10/32" [16.0 cm]	31.5 [14.3]	36.5 [16.6]

Dimensions and weights are for reference only. Weights listed are for pump only; motor not included.

[†]Varies with motor manufacturer.



finishthompson.com

FINISH THOMPSON INC. - UNITED STATES

921 Greengarden Road | Erie, PA 16501
 800.934.9384 | ph 814.455.4478 | fx 814.455.8518
 email fti@finishthompson.com

FINISH THOMPSON INC. - GERMANY

Otto-Hahn-Strasse 16 | Maintal, D-63477 Germany
 49 (0)6181-90878-0 | fx 49 (0)6181-90878-18
 email fti@finishthompson.com