

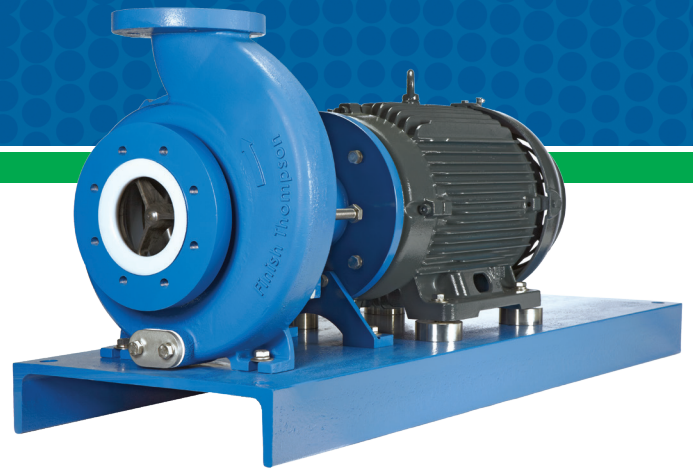

# UC SERIES

## MODEL UC4310H (A70 - 4X3X10)



### UC4310H PERFORMANCE 1750 RPM, 60 Hz

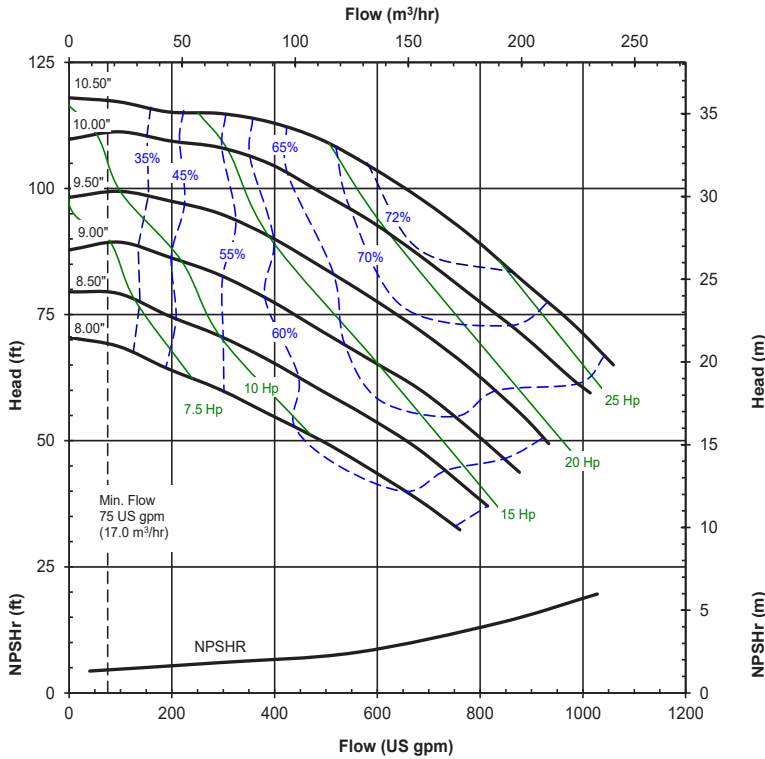

### UC4310H PERFORMANCE 1450 RPM, 50 Hz

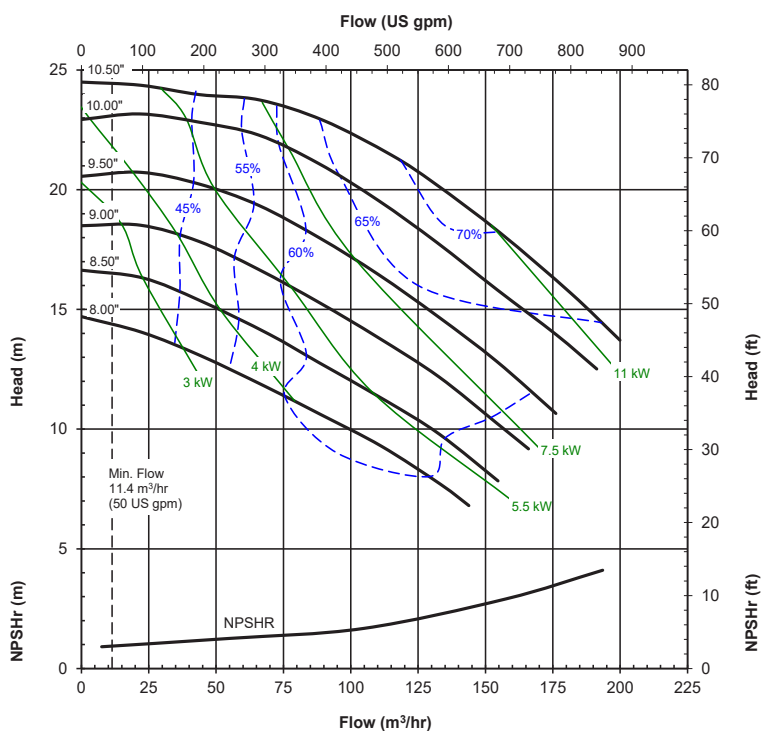

## FEATURES

- Durable, corrosion-resistant Tefzel® lined ductile iron casing
- Casing meets ANSI B73.1m & 73.3 for foot and flange location
- Powerful neodymium magnets for dependable, leak-free operation
- Conventional volute
- Rear sealing ring to balance axial thrust
- Dual bushings provide optimum alignment
- Suction shaft support with integral straightening vanes
- Replaceable 2-piece impeller and drive hub
- Run dry capability with carbon or Dri-Coat SiC bushing
- Easy-set measurement free outer drive
- Exclusive vapor protection package to protect outer magnetic drive and motor face from corrosive fumes
- Back pull-out design
- Casing drain standard
- Specific gravity over 1.8
- Accepts standard NEMA 143-405 or IEC 90-280 motor frames
- ANSI or ISO flange mountable
- ATEX certified models available



## TYPICAL APPLICATIONS

- Paper Mills
- Water treatment
- Plating & metal finishing
- Chemical manufacturing, blending, distribution
- Fume scrubbers
- Pharmaceuticals
- Truck loading/unloading
- Metals manufacturing
- Electronics

## TYPICAL CHEMICALS

- Sodium hydroxide
- Sulfuric acid
- Hydrochloric acid
- Sodium hypochlorite
- Plating solutions
- Corrosive blends
- Solvents
- Wastewater

\*Tefzel® Fluoropolymer Resin is a registered trademark of DuPont

# UC SERIES

Item No.	Description	Construction
1	Casing	Cast ductile iron, DuPont Tefzel® (ETFE) lined
2	Shaft support	Carbon fiber filled ETFE
2A	Front thrust ring	Alpha sintered silicon carbide
3	Impeller	Carbon fiber filled ETFE
3A	Impeller thrust washer	Alpha sintered silicon carbide
4	Inner drive	Neodymium iron boron magnets encapsulated in ETFE
4A	Bushing	Alpha sintered silicon carbide, Dri-Coat silicon carbide, or carbon
4C	Rear sealing ring	GF molybdenum disulfide-filled PTFE
5	Shaft	Alpha sintered silicon carbide
6	Barrier	Molded CF ETFE liner with Aramid Reinforced Epoxy external shell
6A	Barrier thrust ring	Alpha sintered silicon carbide
7	Clamp ring	Painted ductile iron
8	Outer drive magnet	Nickel-plated neodymium iron boron magnets/painted ductile iron
9	Motor adapter	Ductile iron
10	O-ring	FKM, EPDM, FEP/FKM, Kalrez®, Simriz®, or Afias®
11	Vapor protection o-rings	Buna

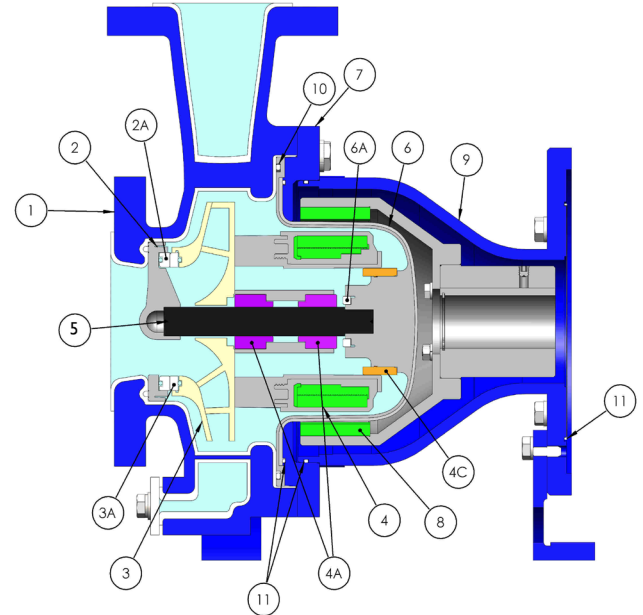

Kalrez® is a registered trademark of DuPont Performance Elastomers  
 Simriz® Perfluoroelastomer is a registered trademark of Simrit® division of Freudenberg-NOK.  
 Afias® is a trademark of the Asahi Glass Co., Ltd.

## SPECIFICATIONS

HP (kW)	Impeller Diameter	Suction	Discharge	Max. Flow 1750 rpm		Max. Head 1750 rpm		Max. Working Pressure psi (Bar)	Max. Viscosity cP	Max. Specific Gravity	Max. Temp.* °F (°C)
	in (cm)	in (cm)	in (cm)	gpm	m <sup>3</sup> /hr	ft.	m				
1 - 50 (1.1- 37)	8 - 10 1/2 (20.3 - 27)	4 (10.2)	3 (7.6)	1050	239	118	36	300 (20.7)	200	1.8	250 (121)

\*Except E magnet set: maximum 220° F (104° C)  
 Note: Impeller trims available every 1/8" (.32 cm) between the smallest and largest diameters.

## DIMENSIONS

### FRONT VIEW

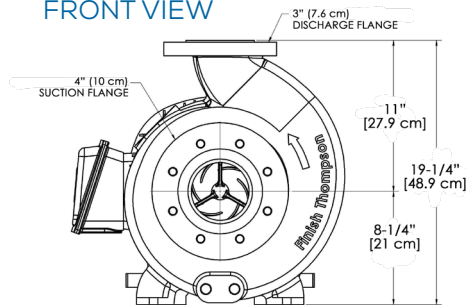

### SIDE VIEW

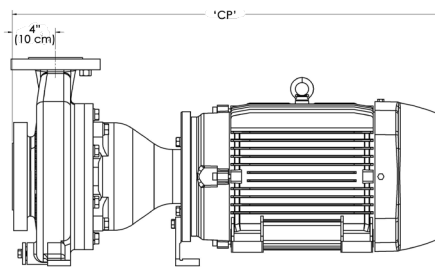

### BOTTOM VIEW

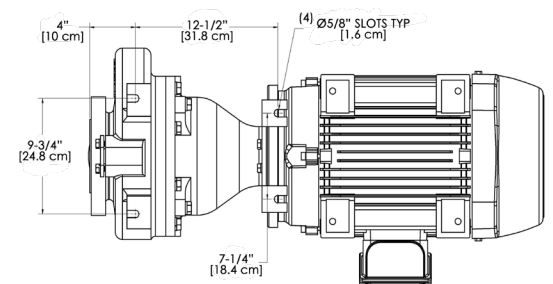

ANSI 150#, 300#, & ISO/  
 DIN PN40 flanges are in  
 compliance with bolting  
 dimensions only.

NEMA Motor Frames	CP (approx.)	
	in	cm
143-145TC	27-11/16	70.3
182/184TC	29-9/16	75.1
213/215TC	32-5/8	82.9
254/256TC	37-1/2	95.3
282/284TC/TSC	39-27/32	101.2
324/326TC/TSC	44-21/32	113.4
364/365TC/TSC	46-27/32	119.0
404/405TSC	50-5/16	127.8

IEC Motor Frames	CP (approx.)	
	in	cm
90	27-15/32	69.8
100/112	28-29/32	73.4
132	32-9/16	82.7
160	38-9/32	97.2
180	40-9/16	103
200	43-3/32	109.5
225	46-21/32	118.5
250	52-17/32	133.4
280	56-3/4	144.1



finishthompson.com

### FINISH THOMPSON INC. - UNITED STATES

921 Greengarden Road | Erie, PA 16501  
 800.934.9384 | ph 814.455.4478 | fx 814.455.8518  
 email fti@finishthompson.com

### FINISH THOMPSON INC. - GERMANY

Otto-Hahn-Strasse 16 | Maintal, D-63477 Germany  
 49 (0)6181-90878-0 | fx 49 (0)6181-90878-18  
 email fti@finishthompson.com