

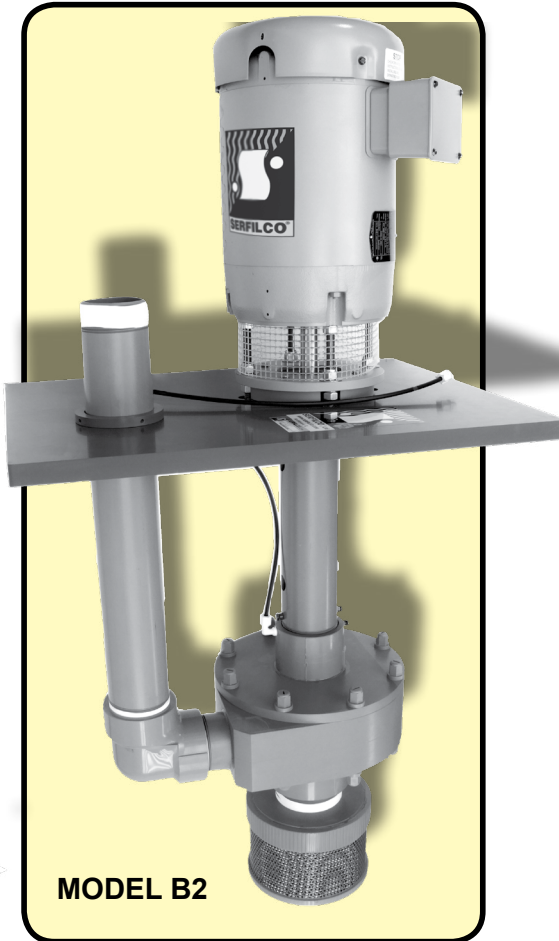

## SERIES 'B' | VERTICAL PUMPS



MODEL B2

### HIGH EFFICIENCY AND LOW ENERGY USAGE FOR:

#### WASTES / ACIDS / PLATING / CHEMICALS

- Flows to 370 U.S. GPM or 84 Ft. TDH @ 60 Hz (1150 LPM or 18.5M @ 50 Hz)
- Pump lengths: 2 ft. to 10 ft. (.6M to 3.0M)
- Corrosion resistant, CPVC construction (See a chemical resistance chart)
- Water or product lubricated bearings
- Chemical duty, 1725 RPM motor (1.0 - 10.0 HP)  
Sealed oversized bearings; cast iron end bells; liquid/vapor seal and slinger; corrosion resistant two-part epoxy finish; 1.15 service factor.
- Centrifugal — quiet, vibration-free
- Shaft vapor seal protects motor bearings and atmosphere

The Series 'B' Pump features corrosion resistant construction for deep sumps and demanding conditions. An oversized machined pump housing is utilized allowing for high flow rates using low RPM motors, thus extending pump life. A stainless steel shaft sleeved in CPVC offers unmatched strength and chemical resistance. A vapor seal between the rotating shaft and the pump column protects the motor and motor bearings.

The shaft bearing and liner are positively lubricated with the product being pumped or clean water from a separate source by means of the bleed line. A spiral flush groove in the rotating bearing ensures a uniform flow of liquid across the bearing surface. The bearing liner is made of a special fluoride-resistant ceramic.

A suction extension can be utilized to pump to depths below impeller level. Thus, a shorter pump can be used, reducing shaft length and number of bearings required.

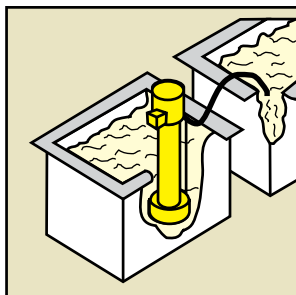

CHEMICAL TRANSFERRING

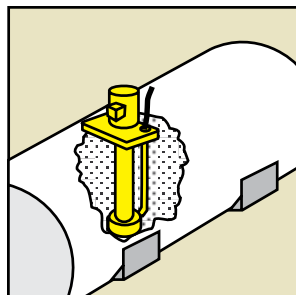

STORAGE TANK

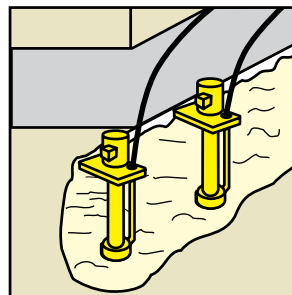

DEEP STANDBY PUMPING  
when priming not possible

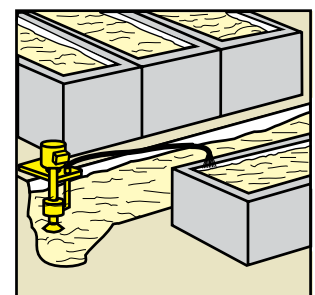

SUMP DRAINING and WASTE TREATMENT



# SERIES 'B' | VERTICAL PUMPS

2900 MacArthur Blvd. Northbrook, IL. USA 60062 www.serfilco.com (800) 323 - 5431

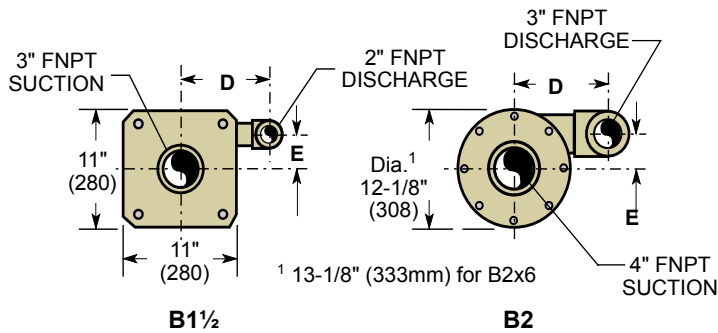
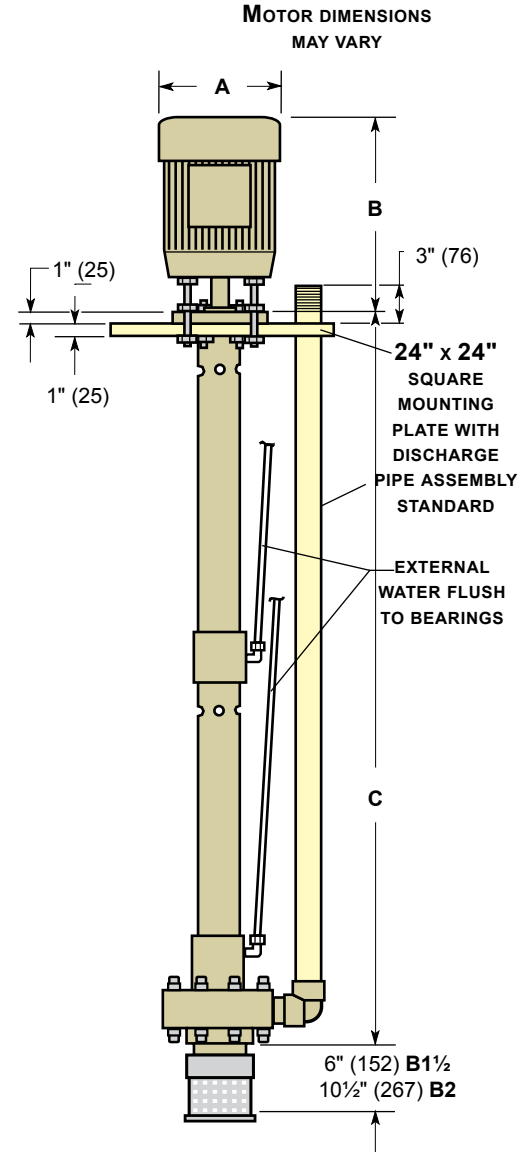
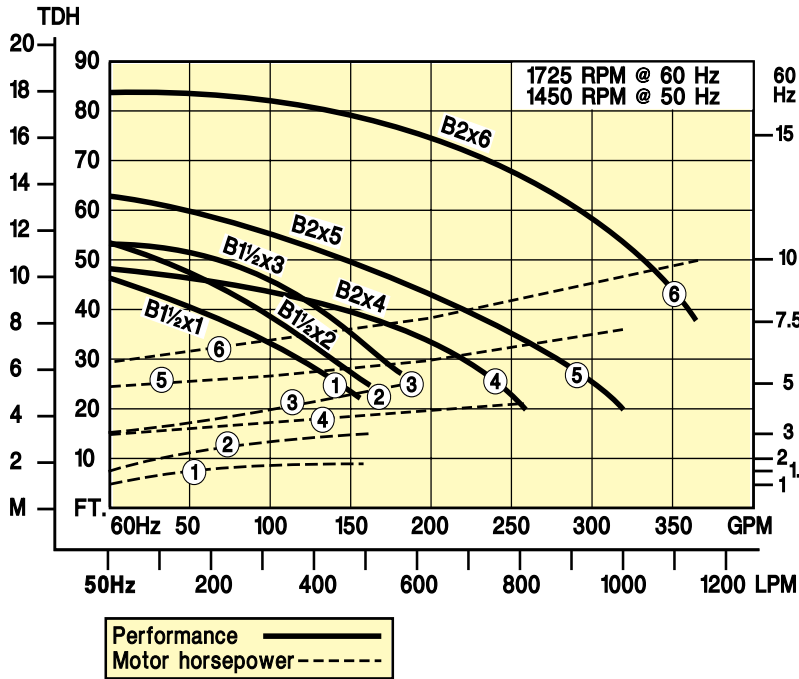

**BOTTOM VIEWS**

PUMP		DIMENSIONS Inches (mm)					HP	MOTOR FRAME	APPROX. SHIPPING WEIGHT <sup>2</sup>	
MODEL	NPT CONNS.	A	B	C	D	E			Lbs.	(Kg.)
B1½ x 1	3" x 2"	7¼ (184)	13¼ (236)	<b>SELECT LENGTH</b>	9 (229)	2-3/4 (70)	1.5	143TC	130	59
			14¼ (362)			2-7/8 (73)	2.0	145TC	135	61
B1½ x 2	3" x 2"	7¼ (184)	14¼ (362)		8-1/2 (216)	2-5/8 (67)	2.0	145TC	140	64
			8½ (216)				3.0	182TC	145	66
B1½ x 3	3" x 2"	8½ (216)	15½ (394)		11-1/8 (283)	3-3/16 (81)	3.0	182TC	150	68
			17¼ (438)				5.0	184TC	170	77
B2 x 4	4" x 3"	8½ (216)	17¼ (438)		11-5/8 (295)	3-3/4 (95)	5.0	184TC	170	77
B2 x 5	4" x 3"	10¼ (260)	18 (457)				7.5	213TC	190	86
B2 x 6	4" x 3"	10¼ (260)	19 (483)				10	213TC	200	91

<sup>2</sup> Add 4½ lb. (2.0 kg.) per foot (.3M) of additional pump length above 2 feet (.6M).



Standard models are constructed of CPVC with high purity chemical resistant graphite or Rulon® (glass filled PTFE) bearing and silica-free ceramic liner for fluoride resistance. Includes threaded suction and discharge. Models B1½ have polyethylene suction strainer, Models B2 have CPVC suction strainer. The "O"-rings are EPDM (Viton optional). Models B1½ have semi-enclosed impellers, Models B2 fully-enclosed impellers. Motors are "C" face, 1725 RPM, 230-460V/3/50-60, TEFC, chemical duty, painted with two-part epoxy enamel. Pump shaft is 303 stainless

steel sleeved in CPVC. Complete pump assembly offers non-metallic solution contact except titanium fasteners at each bearing (Hastelloy® C 257 optional). Pump lengths are available in one foot (.3M) increments. Bleed line provides water or pumped solution to bearings. (Each bearing requires 10 PSI.) All models wet-tested before shipment. Standard is external water flush. Product flush may be specified, or field converted. All models include 24" x 24" square mounting plate and discharge pipe assembly.

**TO ORDER, use Price Code Number**

**For standard 24" - 60" pump-motor combinations, select model from TABLE I.  
For custom pump-motor combination, select components from TABLE II on page 4.**

**TABLE I**

Select flow curve number providing the desired performance.  
Then match to Model Numbers listed below.  
Motor HP is non-overloading at full capacity.

CURVE NO.	24" PUMP		36" PUMP	
	MODEL	PRICE CODE NO.	MODEL	PRICE CODE NO.
1	B1½ x 1SCEY-24"C-CGL- * °F-H2.0-SD	46-1024 BS	B1½ x 1SCEY-36"C-CGL- * °F-H2.0-SD	46-1034 BS
2	B1½ x 2SCEY-24"C-CGL- * °F-H3.0-SD	46-2024 CS	B1½ x 2SCEY-36"C-CGL- * °F-H3.0-SD	46-2034 CS
3	B1½ x 3SCEY-24"C-CGL- * °F-H5.0-SD	46-3024 DS	B1½ x 3SCEY-36"C-CGL- * °F-H5.0-SD	46-3034 DS
4	B2 x 4SCEY-24"C-CGL- * °F-H5.0-SD	46-4024 DS	B2 x 4SCEY-36"C-CGL- * °F-H5.0-SD	46-4034 DS
5	B2 x 5SCEY-24"C-CGL- * °F-H7.5-SD	46-5024 ES	B2 x 5SCEY-36"C-CGL- * °F-H7.5-SD	46-5034 ES
6	B2 x 6SCEY-24"C-CGL- * °F-H10.0-SD	46-6024 FS	B2 x 6SCEY-36"C-CGL- * °F-H10.0-SD	46-6034 FS

CURVE NO.	48" PUMP		60" PUMP	
	MODEL	PRICE CODE NO.	MODEL	PRICE CODE NO.
1	B1½ x 1SCEY-48"C-CGL- * °F-H2.0-SD	46-1044 BS	B1½ x 1SCEY-60"C-CGLX2- * °F-H2.0-SD	46-1055 BS
2	B1½ x 2SCEY-48"C-CGL- * °F-H3.0-SD	46-2044 CS	B1½ x 2SCEY-60"C-CGLX2- * °F-H3.0-SD	46-2055 CS
3	B1½ x 3SCEY-48"C-CGL- * °F-H5.0-SD	46-3044 DS	B1½ x 3SCEY-60"C-CGLX2- * °F-H5.0-SD	46-3055 DS
4	B2 x 4SCEY-48"C-CGLx2- * °F-H5.0-SD	46-4045 DS	B2 x 4SCEY-60"C-CGLX2- * °F-H5.0-SD	46-4055 DS
5	B2 x 5SCEY-48"C-CGLx2- * °F-H7.5-SD	46-5045 ES	B2 x 5SCEY-60"C-CGLX2- * °F-H7.5-SD	46-5055 ES
6	B2 x 6SCEY-48"C-CGLx2- * °F-H10.0-SD	46-6045 FS	B2 x 6SCEY-60"C-CGLX2- * °F-H10.0-SD	46-6055 FS

\* Include operating temperature in Model Number.



**TABLE II** Determine pump model for a specific GPM, TDH, pump length and bearing. Select performance point on curve and size horsepower from corresponding number dotted line vertically above

or below performance point. Read required HP at right ordinate and multiply by specific gravity. Select pump model components and Price Code Number from Table II.

PUMP		
PUMP CURVE	MODEL NUMBER	PRICE CODE NO.
1	B1½ x 1SCEY	46-1
2	B1½ x 2SCEY	46-2
3	B1½ x 3SCEY	46-3
4	B2 x 4SCEY	46-4
5	B2 x 5SCEY	46-5
6	B2 x 6SCEY	46-6

- LENGTH (Dimension C)					
		NO. of BEARINGS		ADD TO ...	
FT.	(M)	B1½	B2	MODEL NUMBER	PRICE CODE NO.
2	.6	1	1	- 24°C	02
3	.9	1	1	- 36°C	03
4	1.2	1	2	- 48°C	04
5	1.5	2	2	- 60°C	05
6	1.8	2	2	- 72°C	06
7	2.1	2	3	- 84°C	07
8	2.4	2	3	- 96°C	08
9	2.7	3	3	- 108°C	09
10	3.1	3	3	- 120°C	10

Read: "Tips for the successful operation of sump pumps". See Technical Bulletin TP-113.

-BEARING & LINER			
MATERIAL NO.	OF BRGS. ADD TO	MODEL NO.	PRICE CODE NO.
Ceramic & Graphite Max. 160°F	1	- CGL-__ °F	4
	2	- CGLx2-__ °F	5
	3	- CGLx3-__ °F	6
Ceramic & Rulon Max. 140°F	1	- CRL-__ °F	1
	2	- CRLx2-__ °F	2
	3	- CRLx3-__ °F	3

\* Include operating temperature in Model Number.

- MOTOR & MOUNTING PLATE			
TEFC , 230-460V/3/50-60 **			
		ADD TO ...	
RPM	HP (kw)	MODEL NO.	PRICE CODE NO.
1725@ 60 Hz	1.0 (.75)	- H1.0-SD	GS
	1.5 (1.1)	- H1.5-SD	AS
	2.0 (1.5)	- H2.0-SD	BS
	3.0 (2.2)	- H3.0-SD	CS
1450@ 50 Hz **	5.0 (3.7)	- H5.0-SD	DS
	7.5 (5.6)	- H7.5-SD	ES
	10.0 (7.5)	- H10.0-SD	FS

\*\* B2 Models are 230-460V/3/60 as standard  
230-380-415V/3/50 FOR 50 Hz models

**OPTIONAL**

DESCRIPTION	ADD SUFFIX to MODEL NO.	ADD TO PRICE CODE NUMBER
Viton "O"-rings	-V	V
Hastelloy C 257 bearing fasteners	-HC	X
50 Hz - B2 Models	-5	5
Round -24" diameter x 1" thick	change -SD to -CD in model	replace S with C in PCN

DESCRIPTION	ADD SUFFIX to MODEL NO.	USE SEPERATE PRICE CODE	
		B1 1/2	B2
Suction extension, CPVC pipe, threaded both ends	-K12"	46-0081	46-0089
	-K24"	46-0082	46-0090
	-K36"	46-0083	46-0091

Consult Sales Dept. for explosion-proof motors, custom pump stations, motor starters, level controls and Dri-Stop flow switch for bearing protection.